



GPS/GLONASS SiRFstarV Evaluation Kit EVA5100-A User Guide

**Part Number PMD-00032
Revision A November 2019**

Intellectual Property

© 2019 Lantronix, Inc. All rights reserved. No part of the contents of this publication may be transmitted or reproduced in any form or by any means without the written permission of Lantronix.

Lantronix is a registered trademark of Lantronix, Inc. in the United States and other countries.

Patented: www.lantronix.com/legal/patents/. Additional patents pending.

Windows and *Internet Explorer* are registered trademarks of Microsoft Corporation. *Firefox* is a registered trademark of the Mozilla Foundation. *Chrome* is a trademark of Google Inc. All other trademarks and trade names are the property of their respective holders.

Warranty

For details on the Lantronix warranty policy, please go to our web site at www.lantronix.com/support/warranty/

Contacts

Lantronix, Inc.

7535 Irvine Center Drive, Suite 100
Irvine, CA 92618, USA
Toll Free: 800-526-8766
Phone: 949-453-3990
Fax: 949-453-3995

Technical Support

Online: www.lantronix.com/support

Sales Offices

For a current list of our domestic and international sales offices, go to the Lantronix web site at www.lantronix.com/about-us/contact/

Disclaimer

All information contained herein is provided "AS IS." Lantronix undertakes no obligation to update the information in this publication. Lantronix does not make, and specifically disclaims, all warranties of any kind (express, implied or otherwise) regarding title, non-infringement, fitness, quality, accuracy, completeness, usefulness, suitability or performance of the information provided herein. Lantronix shall have no liability whatsoever to any user for any damages, losses and causes of action (whether in contract or in tort or otherwise) in connection with the user's access or usage of any of the information or content contained herein. The information and specifications contained in this document are subject to change without notice.

Open Source Software

Some applications are Open Source software licensed under the Berkeley Software Distribution (BSD) license, the GNU General Public License (GPL) as published by the Free Software Foundation (FSF), or the Python Software Foundation (PSF) License Agreement for Python 2.7.3 (Python License). Lantronix grants you no right to receive source code to the Open Source software; however, in some cases, rights and access to source code for certain Open Source software may be available directly from Lantronix' licensors. Your use of each Open Source component or software is subject to the terms of the applicable license. The BSD license is available at <http://opensource.org/licenses>. The GNU General Public License is available at <http://www.gnu.org/licenses/>. The Python License is available at <http://cmpt165.csil.sfu.ca/Python-Docs/license.html>. Your use of each Open Source component or software is subject to the terms of the applicable license.

OPEN SOURCE SOFTWARE IS DISTRIBUTED WITHOUT ANY WARRANTY, INCLUDING ANY IMPLIED WARRANTY OF MERCHANTABILITY OR FITNESS FOR A PARTICULAR PURPOSE. SEE THE APPLICABLE LICENSE AGREEMENT FOR ADDITIONAL INFORMATION.

You may request a list of the open source components and the licenses that apply to them. Contact your regional Lantronix sales associate. www.lantronix.com/about-us/contact/

Revision History

Date	Rev.	Comments
February 2014	0.1	First Release
November 2019	A	Added Lantronix document part number, Lantronix logo, branding, contact information, and links.

For the latest revision of this product document, please check our online documentation at www.lantronix.com/support/documentation.

Table of Contents

Intellectual Property	1
Warranty	2
Contacts	2
Disclaimer	2
Open Source Software	3
Revision History	3
Table of Contents	4
1 Introduction	7
1.1 Purpose	7
1.2 Contents	7
1.3 Ordering Information	9
1.4 Handling Precautions	9
2 Quick Start	10
3 Potential Problems with Windows	13
3.1 Ballpoint Mouse	13
4 Board Overview	14
5 On-Board Peripherals	15
5.1 ON and RESET Push-Button	15
5.2 Antenna Connector	15
5.3 LEDs	16
6 Design-in Support	17
6.1 Terminal Block	17
6.2 DIP Switch Settings	18
6.3 ICC Jumper	18
7 NMEA Port	19
8 Board Schematics	20
9 Related Information	22
9.1 Related Documents	22
9.2 Related Tools	22

List of Figures

Figure 1: Evaluation board EVA5100-A.....	8
Figure 2: Active GPS/GLONASS antenna with SMA connectors	8
Figure 3: USB cable with A/B type connectors.....	8
Figure 4: CD.....	8
Figure 5: Windows driver installation warning	10
Figure 6: SiRFLive GSD5xp RS232/USB Settings window	11
Figure 7: SiRFLive Debug View with NMEA data.....	12
Figure 8: Disabling of Microsoft Serial BallPoint.....	13
Figure 9: Board overview	14
Figure 10: Antenna connector	15
Figure 11: EVA5100-A LEDs.....	16
Figure 12: Terminal block.....	17
Figure 13: DIP switches (picture turned by 90° ccw).....	18
Figure 14: ICC jumper	18
Figure 15: Minimum configuration A5100-A	20
Figure 16: EVA5100-A board schematics	21

List of Tables

Table 1: LEDs function and description.....	16
Table 2: Terminal block description.....	17
Table 3: Switch settings	18

1 Introduction

1.1 Purpose

The GPS/GLONASS Evaluation Kit EVA5100-A allows an easy evaluation of Lant-ronix's SiRFstarV GPS/GLONASS receiver module A5100-A by offering quick access to the serial ports and the most important I/O lines of the module.

The EVA5100-A serves three major purposes:

- As a demonstration package of the module's capabilities
Powering the A5100-A GPS/GLONASS receiver module via the USB connector and connecting the GPS/GLONASS antenna with sufficient view to the sky will result in an NMEA output with position information.
- As an example how to integrate the module into a system

2 The schematic in chapter "1

Board Schematics” is a basic example of how to integrate the GPS/GLONASS module into an application or system.

- To support an easy temporary design in
The signals provided on the Evaluation Kit allow direct integration into a surrounding system making it an ideal development tool.

The EVA5100-A can especially demonstrate that an active GPS/GLONASS antenna connected to the Antenna Input will result in outstanding GPS/GLONASS performance.

2.1 Contents

The EVA5100-A includes the following components:

- Evaluation Board (labeled EVA5100-A) with one A5100-A GPS/GLONASS receiver
- Active GPS/GLONASS antenna
- USB cable to connect to your PC
- CD with complete documentation and SiRFLive 2.04P1 Marketing software

Please check your package for completeness and connect the components properly.



Figure 1: Evaluation board EVA5100-A



Figure 2: Active GPS/GLONASS antenna with SMA connectors



Figure 3: USB cable with A/B type connectors



Figure 4: CD

2.2 Ordering Information

The complete order number for the EVA5100-A is

- EVA5100-A

The board will always be shipped with latest part number. Information on sales channels can be found on Lantronix’s web page.

2.3 Handling Precautions

The EVA5100-A contains components that are sensitive to electrostatic discharge (ESD). Please handle with appropriate care.

3 Quick Start

- (1) Connect the EVA5100-A with your PC using the included USB cable.
- (2) When the PC asks for drivers select the folder “Tools\Drivers” on the included CD ROM.

Note: Two drivers need to be installed, the [EVA5100-A FTDI driver](#) and the [USB serial driver](#).

Note: During the driver installation process your Windows system will probably notify you, that the driver did not pass Windows logo testing with a warning:

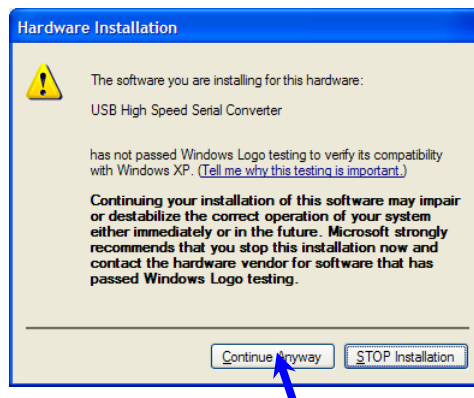
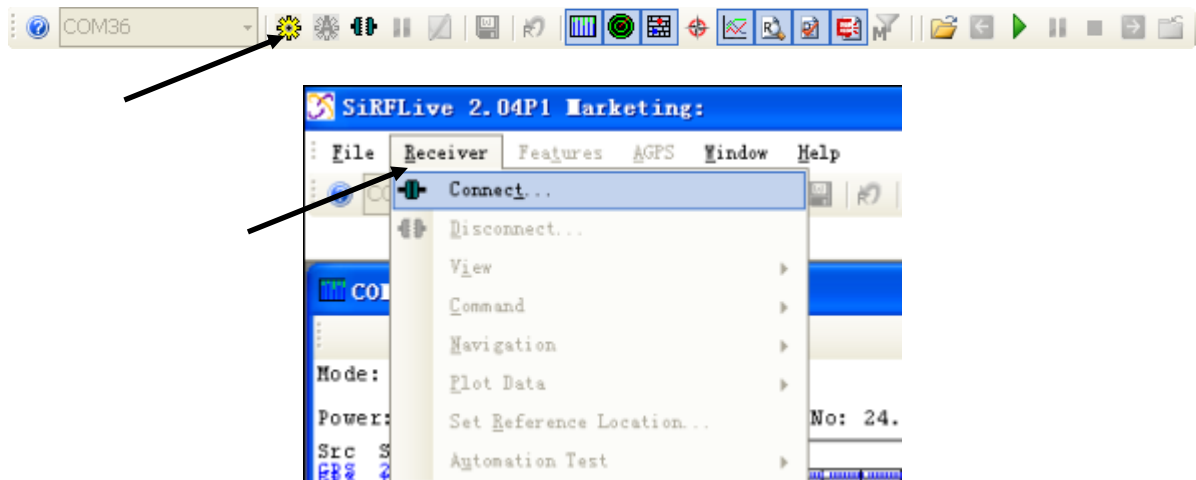

Figure 5: Windows driver installation warning

- (3) Connect the included active GPS/GLONASS antenna to the antenna connector of the EVA5100-A; make sure that the antenna has a good view to the sky!
- (4) Make sure all DIP switches are in ON position except for the GPIO7, NC pin DIP switch which must be in OFF position.
- (5) To start the SiRFLive software which visualizes the NMEA output data coming from the GPS/GLONASS receiver, copy all files from the included CD ROM “Tools/ SiRFLive” to a folder of you choice on your PC. Then double click the SiRFLive.exe file. The SiRFLive software starts installation. A detailed description of the SiRFLive software is included on the CD ROM.

- (6) Activate the correct port within SiRFLive. You can do this by selecting the “Receiver Settings button” icon (left-most icon) or by choosing “Connect” in the “Main Toolbar” menu.



In both cases the following window will appear:

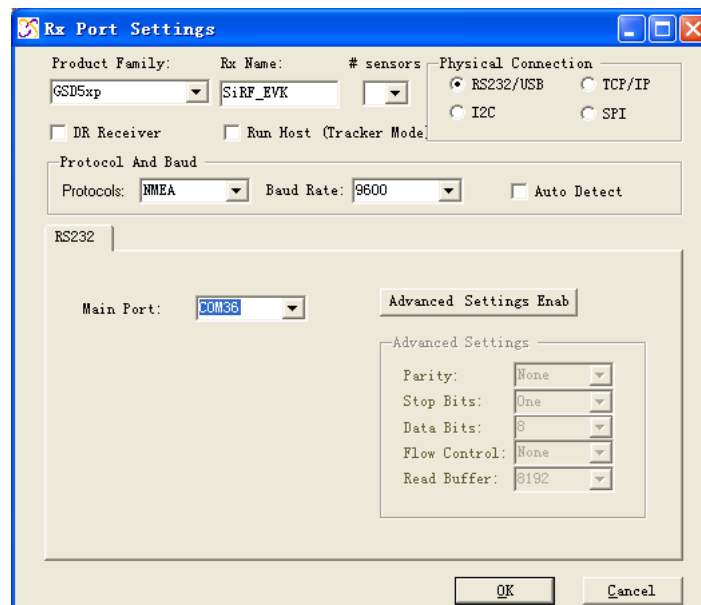

Figure 6: SiRFLive GSD5xp RS232/USB Settings window

Choose the Main port to which the GPS/GLONASS receiver is connected (verify in your system settings - device manager, which communication port is used for this USB serial connection), in our example COM36 at 9600 baud NMEA Protocol (default setting for the EVA5100-A), click on “OK”:

- (7) Open the Debug View window to see NMEA sentences by using the “Debug View” window button. You will see no messages!



- (8) In order to start the module, you need to push the “ON” button of the evaluation board. Then only you will see messages like this:

```

COM36: Debug View SW Version: Not detected
Courier New 9
$GNGSA,A,3,14,22,21,29,,,,,,,,,2.3,1.6,1.7*21
$GNGSA,A,3,82,83,68,69,,,,,,,,,2.3,1.6,1.7*2C
$GPGSV,3,1,12,14,14,253,32,22,13,309,30,21,65,281,26,29,11,201,18*78
$GPGSV,3,2,12,12,10,148,04,18,41,331,13,26,05,049,12,24,72,093,*79
$GPGSV,3,3,12,15,39,030,,57,25,125,,05,12,103,,25,00,181,*7F
$GLGSV,3,1,09,82,18,209,34,83,28,276,28,68,34,349,16,69,06,304,11*67
$GLGSV,3,2,09,67,30,054,13,78,59,108,,77,28,040,,79,26,177,*63
$GLGSV,3,3,09,84,06,323,*54
$GNRMC,064701.000,A,2232.0502,N,11403.7987,E,0.00,99.96,150114,,A*4B
$GPGGA,064702.000,2232.0502,N,11403.7987,E,1,05,1.6,112.5,M,-2.0,M,,0000*41
$GNGNS,064702.000,2232.0502,N,11403.7987,E,AA,09,1.6,112.5,-2.0,,0000*79
$GNGSA,A,3,14,22,21,18,29,,,,,,,,,2.3,1.6,1.7*28
$GNGSA,A,3,82,83,68,69,,,,,,,,,2.3,1.6,1.7*2C
bytes/s

```

Figure 7: SiRFLive Debug View with NMEA data

Now you can start using all the other windows and features of SiRFLive. Please refer also to the SiRFLive manual and the online help within SiRFLive.

4 Potential Problems with Windows

4.1 Ballpoint Mouse

After successful driver installation and after pushing the “ON” button of the EVA5100-A Windows might interpret the data coming over the serial interface as a serial ballpoint mouse! Your mouse pointer can start jumping around. To stop this, disable the according device using your device manager. Leave the EVA5100-A kit connected and push the nRST button once. The module will stop to transmit data. To fix the problem you will find the device under “Mice and other pointing devices”. Use a right click to open the sub-menu and disable the device.

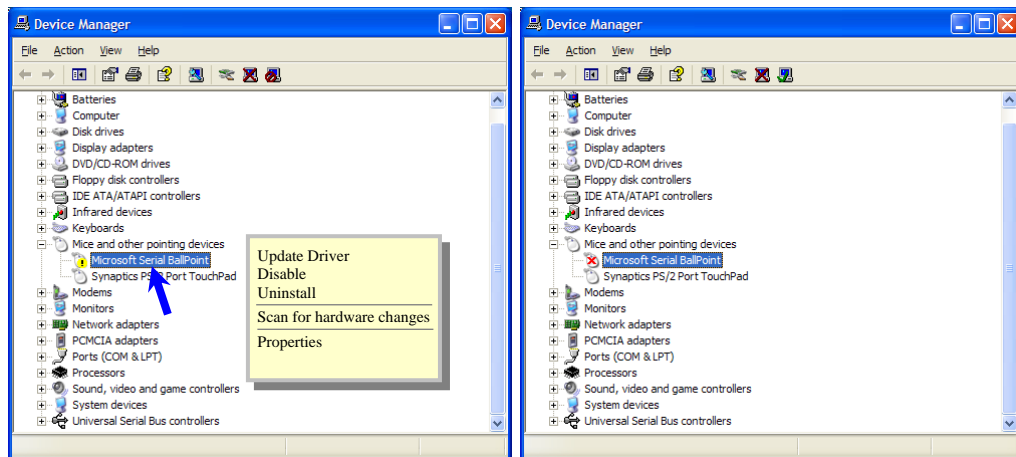

Figure 8: Disabling of Microsoft Serial BallPoint

Afterwards you will be able to continue in a normal way. Don't forget to push the “ON” button again to receive NMEA data.

5 Board Overview

The following picture shall give an overview on the complete evaluation board EVA5100-A. It explains the most important components and can be used as a reference for the next paragraphs.

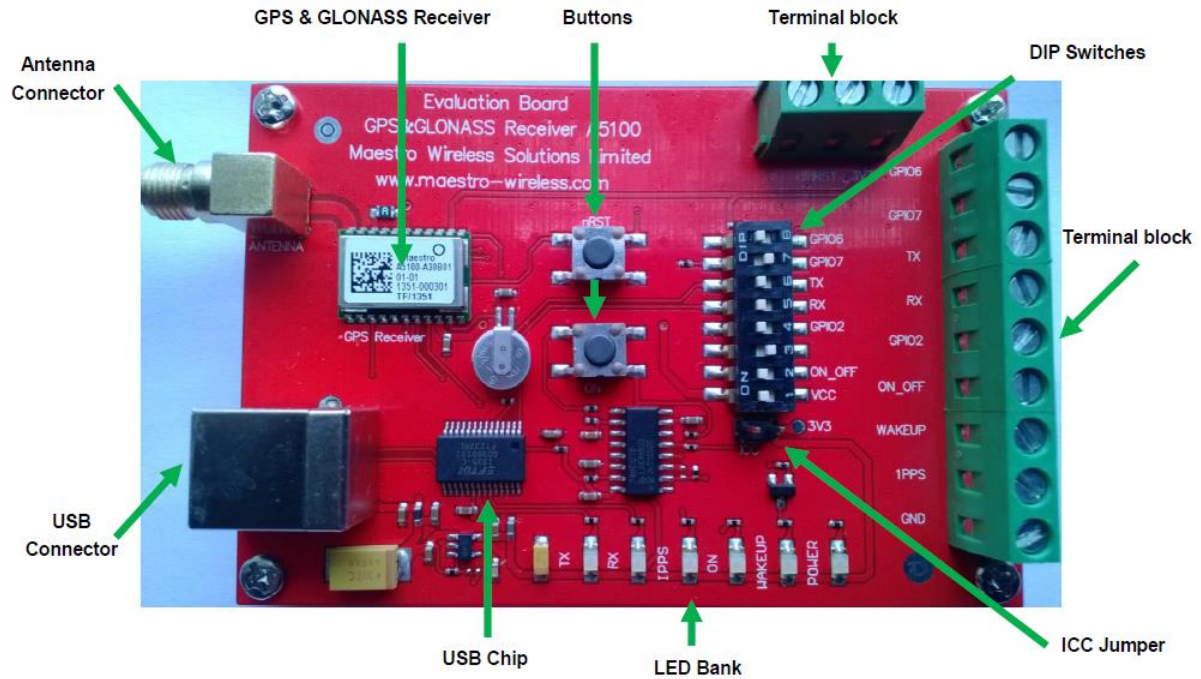

Figure 9: Board overview

6 On-Board Peripherals

6.1 ON and RESET Push-Button

The EVA5100-A has two push-buttons:

- ON (ON / OFF functionality)
- nRST (RESET functionality)

After power on pushing the “ON” button will start the A5100-A module. This is absolutely necessary to get the module going. The “ON” button must be used as well in other cases, e.g. in order to request a position when in SiRFaware™ state or to go to hibernate mode and wake up again.

The “nRST” button is used to get a full reset of the GPS/GLONASS module. All parameters are stored in non-volatile memory. After pushing this button the module starts again from the beginning.

6.2 Antenna Connector

The A5100-A supports one antenna input. Both active and passive GPS/GLONASS antennas can be connected to GPS/GLONASS input as below. Only active GPS/GLONASS antenna was equipped inside evaluation kit.



Figure 10: Antenna connector

6.3 LEDs

There are 6 LEDs on the EVA5100-A that indicate different signals from the GPS/GLONASS receiver (order of LED's on EVA5100-A from left to right):

LED	Name	Function	Description
D3	TX	Transmit	Serial data traffic (from GPS/GLONASS receiver)
D2	RX	Receive	Serial data traffic (into GPS/GLONASS receiver)
D6	1PPS	Timing	1PPS signal at rising edge (1 pulse per second, duration 500 ms typ.)
D5	ON	ON	ON after Reset, position request during PTF cycle and in SiRFaware mode (the LED visualizes the ON pulse)
D1	WAKEUP	Operational state	HIGH: Full operation LOW: Module in a low power mode
D4	POWER	Power/Vcc	Power on LED

Table 1: LEDs function and description



Figure 11: EVA5100-A LEDs

7 Design-in Support

The EVA5100-A Evaluation board offers the possibility to implement the A5100-A GPS/GLONASS receiver module temporarily into your design by using the terminal block with 15 connections. To operate the EVA5100-A via this terminal block, please check “Table 3: Switch settings”.

Please note:

- VCC power input is not protected against reversed polarity
- External supply has to be within the range of 3.3 to 3.6 VDC

7.1 Terminal Block

The terminal block offers direct access to the A5100-A GPS/GLONASS receiver pins.

Pin	Port
1	NC
2	nRST
3	3V3
4	GPIO6
5	GPIO7
6	TX
7	RX
8	GPIO 2
9	ON_OFF
10	WAKEUP (operational mode)
11	1PPS (Pulse Per Second)
12	GND

Table 2: Terminal block description



Figure 12: Terminal block

7.2 DIP Switch Settings

The following picture shows the DIP switches of the EVA5100-A.

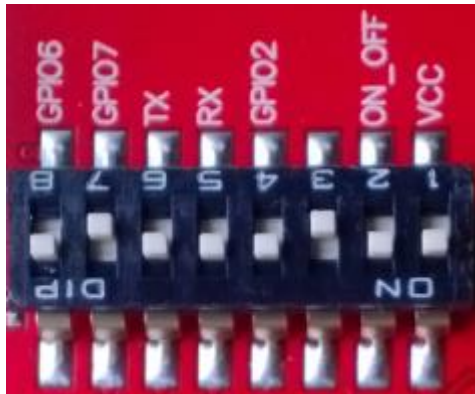

Figure 13: DIP switches (picture turned by 90° ccw)

Switch	Function	Operation via USB connector (default settings)	Operation via terminal block
S1	VCC	ON	OFF
S2	ON_OFF	ON	OFF
S3	NC	OFF	OFF
S4	GPIO2	ON	OFF
S5	RX	ON	OFF
S6	TX	ON	OFF
S7	GPIO7	OFF	OFF
S8	GPIO6	ON	OFF

Table 3: Switch settings

7.3 ICC Jumper



Figure 14: ICC jumper

As long as the VCC DIP switch is “ON” the ICC jumper is bridged. By putting the VCC DIP switch to the OFF position the current draw of the A5100-A GPS/GLONASS receiver can be measured directly by connecting a low resistance measurement device to the ICC jumper.

The low resistance measurement device should be connected before VCC is switched off!

8 NMEA Port

- Default setting: 9600 baud, 8 data bits, no parity, 1 stop bit, no flow control!
- Standard NMEA-0183 output on NMEA, baud rate selectable.
- Standard USB connectors

9 Board Schematics

The following shows the schematics of the EVA5100-A. For best readability the picture was enlarged to cover the complete page.

Please note that the design is done in a way that it reflects the Minimum Configuration as outlined in the GPS/GLONASS Receiver Manual A5100! These are especially:

- The A5100-A needs an external pull-up resistor to be configured for UART operation. Please consider the pull-up resistor in your design or pull the GPIO up right after reset by other means.
- The ON_OFF input of the A5100-A needs to be connected to a push-pull output of a microprocessor. For a wake-up, including the initial one after power on, a LOW-HIGH transmission is mandatory.
- The nRST pin of the A5100-A needs to be connected to an open collector / open drain output of a microprocessor! This is necessary to work with SiRFaware™. Pulling nRST low and afterwards toggling of ON_OFF will get the module to report a position fix when in SiRFaware™ mode.

The following picture shows the minimum configuration for using the A5100-A in UART mode with a passive antenna. In addition VANT are supported on the evaluation board!

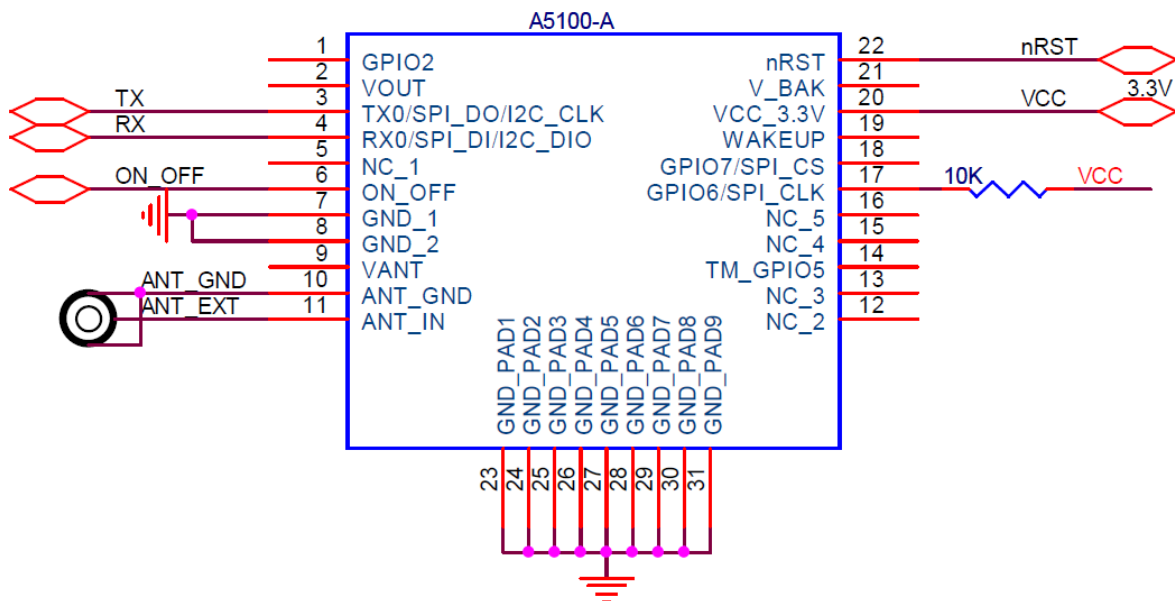

Figure 15: Minimum configuration A5100-A

10 Related Information

10.1 Related Documents

- GPS/GLONASS Receiver A5100 (Lantronix)
- SiRF_NEMA_Reference_Manual (SiRF)
- SiRF_OSP_Reference_Manual (SiRF)

10.2 Related Tools

- SiRFLive (SiRF)