



PS-DC-DUAL-5624T

345 Watt Isolated Power Supply with 56VDC and
24 VDC Dual Output

Install Guide

Intellectual Property

© 2022-2024 Lantronix, Inc. All rights reserved. No part of the contents of this publication may be transmitted or reproduced in any form or by any means without the written permission of Lantronix.

Lantronix is a registered trademark of Lantronix, Inc. in the United States and other countries. All other trademarks and trade names are the property of their respective holders.

Patented: <https://www.lantronix.com/legal/patents/>; additional patents pending.

Warranty

For details on the Lantronix warranty policy, go to <http://www.lantronix.com/support/warranty>.

Contacts

Lantronix Corporate Headquarters

48 Discovery, Suite 250
Irvine, CA 92618, USA
Toll Free: 800-526-8766
Phone: 949-453-3990
Fax: 949-453-3995

Technical Support

Online: <https://www.lantronix.com/technical-support/>

Sales Offices

For a current list of our domestic and international sales offices, go to www.lantronix.com/about/contact.

Disclaimer

All information contained herein is provided "AS IS." Lantronix undertakes no obligation to update the information in this publication. Lantronix does not make, and specifically disclaims, all warranties of any kind (express, implied or otherwise) regarding title, non-infringement, fitness, quality, accuracy, completeness, usefulness, suitability or performance of the information provided herein. Lantronix shall have no liability whatsoever to any user for any damages, losses and causes of action (whether in contract or in tort or otherwise) in connection with the user's access or usage of any of the information or content contained herein. The information and specifications contained in this document are subject to change without notice.

Revision History

Date	Rev	Notes
7/29/19	A	Initial release at FW Rev. 1.0.4.
8/19/19	B	Revise specs, labels and model number.
9/18/19	C	Add power cord information.
11/9/21	D	Remove PS-DC-DUAL-5612T references and update specifications.
1/26/22	E	Initial Lantronix re-brand.
4/23/24	F	Update contact information and graphics, add NDAA and TAA compliance,

Table of Contents

1	Introduction	4
	Ordering Information	4
	Features	4
	Specifications	5
	Power Cord Specifications	6
	27275 AC Power Cord with locking; -NA Line Cord, Right angle.....	6
	27274 AC Power Cord with locking; -NA Line Cord	7
	3344 AC Power Cord; non-locking; -NA Line Cord	8
	Connectors and LEDs	9
	Dimensions.....	10
	Power Cords.....	10
	Front Panel Descriptions	11
2	Installation	12
	Cautions and Warnings	12
	Unpacking	13
	Mounting.....	14
	Grounding.....	14
	Connecting POWER OUTPUT.....	14
	Connecting AC INPUT	14
	PWR (Power) LED	15
	Fuse Replacement	15
	Installing TN 16210 Ferrite.....	15
	Related Manuals	16
	Application Example.....	16
3	Related Information	17
	Troubleshooting.....	17
	Compliance Information	17
	Electrical Safety Warnings	18
	Product Label and Box Label	18

1 Introduction

The Power Supply provides 345W at 56VDC and is targeted for PoE applications. The Power Supply is fully compliant with IEEE 802.3af, at, and bt PoE standards for isolation. It provides a secondary fully-isolated 24V at 1.25A (30W) output for other equipment.

Ordering Information

Model	Description
PS-DC-DUAL-5624T	Hardened 345 Watt Isolated Power Supply with 56VDC and 24VDC Dual Output
PS-DC-DUAL-5624T-AL	Hardened 345 Watt Isolated Power Supply with 56VDC and 24VDC Dual Output with Locked –NA Power Cord
27274	AC Power Cord with locking; -NA Line Cord
3344	AC Power Cord; non-locking; -NA Line Cord
27275	AC Power Cord with locking; -NA Line Cord, Right angle

Features

- Wide 100-240VAC input with externally accessible fuse
- 56 VDC output provides plenty of margin for the powered device (PD) to meet minimum PSE output voltage requirements:
 - IEEE 802.3af (44VDC, 12V margin)
 - IEEE 802.3at (50VDC, 6V margin)
 - IEEE 802.3bt (52VDC, 4V margin)
- Desktop mountable / DIN rail form factor
- Full compliance with the IEEE 2250 VDC PoE isolation requirements
- Active fan speed control based on temperature (PWM)
- Front panel LED for power supply status (Normal and Alarm)
- 2-Pin Alarm DC relay output monitoring five events:
 - Fan tachometer monitoring for low speed and lock conditions
 - Over- or under-temperature
 - 24V output out of spec
- UL approval
- NDAA and TAA compliant
- 5 year warranty

Specifications

Output 1	Voltage 56V (terminal block) Regulation +/- 2% Current Rating 5.7A Power Rating 315W
Output 2	Voltage 24V (terminal block) Regulation +/- 5% Current Rating 1.25A Power Rating 30W
Input Voltage Range	100-240VAC
Input Frequency Range	47 - 63 HZ
Power Consumption	4.0A at 120VAC typical
Dimensions (HxWxD)	Width: 6.25" [159 mm] x Depth: 6.45" [164 mm] x Height: 1.75" [44 mm]
Weight	1.8 lbs. (0.72Kg)
Environment	Operating Temp.: -20°C to +70°C (restricted); -20°C to +50°C (unrestricted) Storage Temp.: -30°C to +70°C Operating Humidity: 5% to 95% (non-condensing)
Alarm output rating	30VDC maximum 50mA maximum
MTBF	623,377 hrs. ENV: GB TEMP: 30.00 deg. C TELCORDIA CALCULATION METHOD: Parts Count (Method I)
Certifications	EMI: EN55032 Class A, EN55024 Safety: IEC 62368-1:2014. Additionally evaluated to: EN 62368-1:2014, EN 62368-1:2014/A11:2017; National Differences specified in the CB Test Report.
Warranty	Five years

Power Cord Specifications

Power cord specifications are provided below.

27275 AC Power Cord with locking; -NA Line Cord, Right angle

Connectors: NEMA 5-15P
IEC-60320-C13
Length: 3 ft. (0.91 m)
Gauge: 18
Jacket Type: SJTW 105°C
Rating: 10A – 125V
Safety: UL

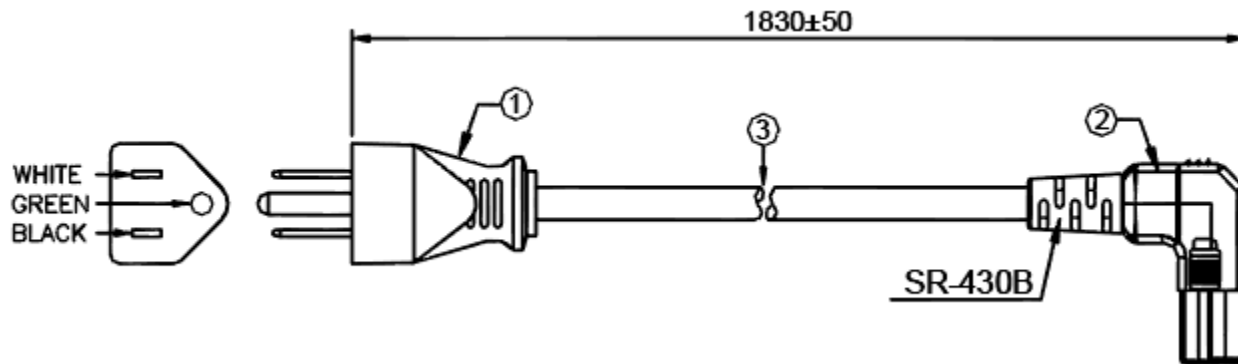

MARKING:

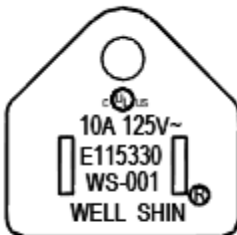

NEMA 5-15P

MARKING:

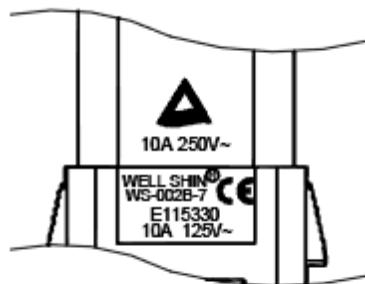

IEC-60320-C13
AUTO-LOCK UP ANGLE

27274 AC Power Cord with locking; -NA Line Cord

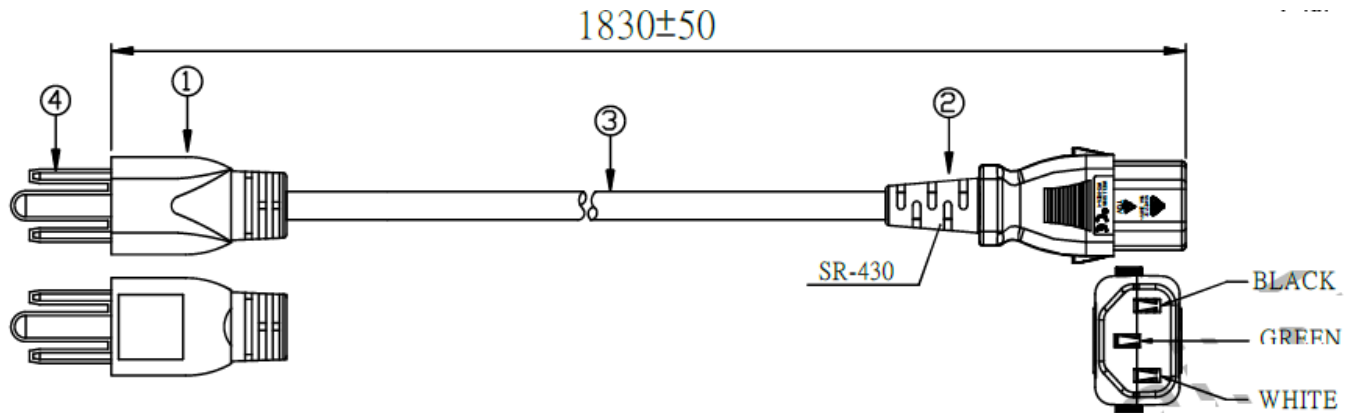

MARKING:

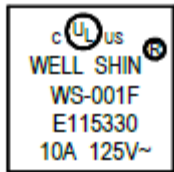

MARKING:

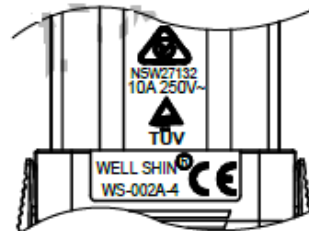

upper cover

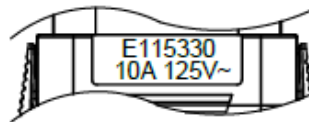

Lower lid

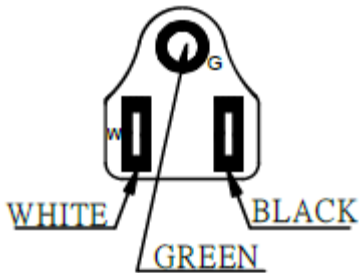

NEMA 5-15P

IEC-60320-C13
AUTO-LOCK

3344 AC Power Cord; non-locking; -NA Line Cord

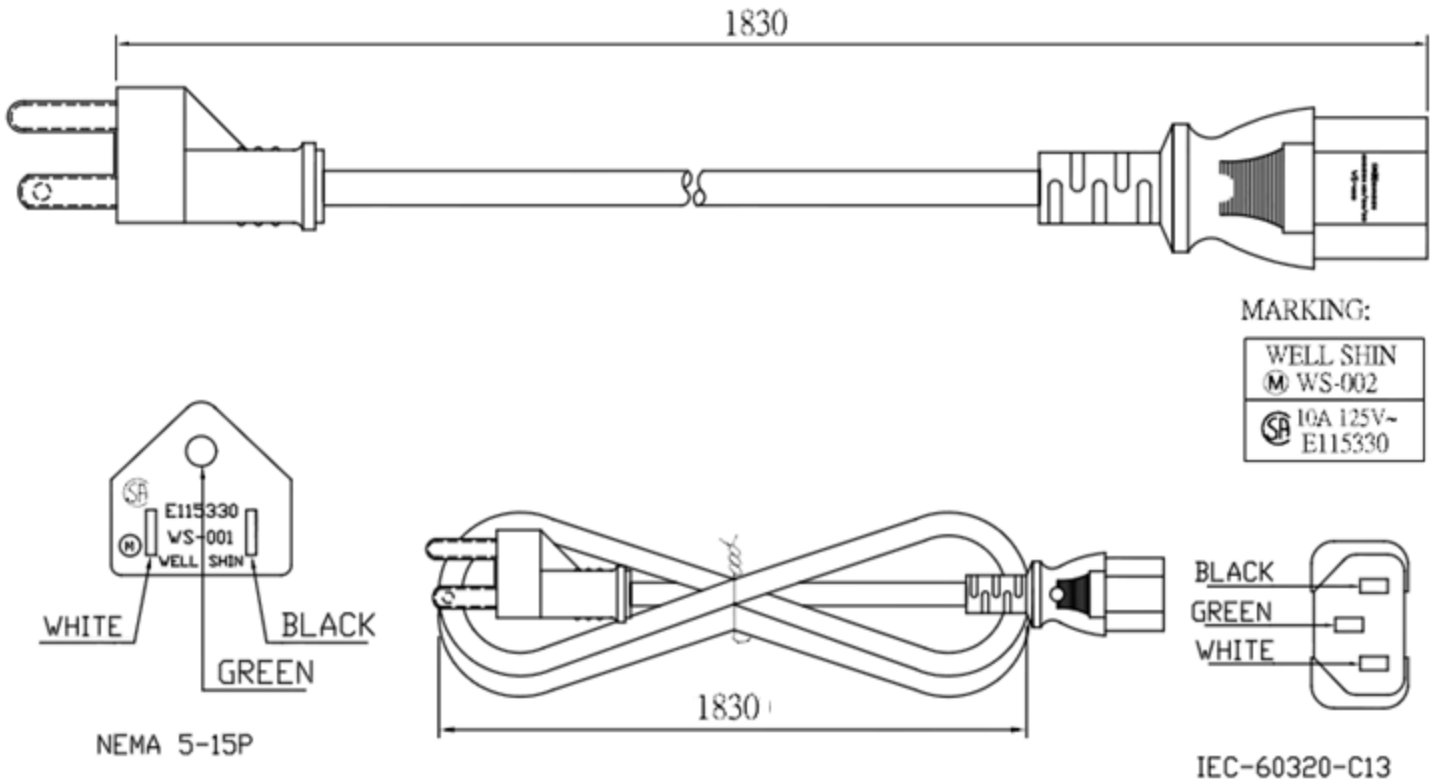

Connectors and LEDs

AC Input

- Connector: IEC C14
- Fuse: 6.3A slo blo
- Power On/Off switch

56VDC and 24VDC output: 6-Pin Terminal Block

- Pin 1: 24Vout+
- Pin 2: 24Vout-
- Pin 3: Alarm Contacts 1
- Pin 4: Alarm Contacts 2
- Pin 5: 56Vout+
- Pin 6: 56Vout-

LEDs

- Power status
 - Green: OK
 - Yellow blink: Will cycle through if one or more events (alarms) occur with one of these Blink Rates:
 - 1 blink per 3 seconds: Fan locked (no tachometer)
 - 2 blinks per 3 seconds: Fan less than 30% PWM (Pulse Width Modulation) setting
 - 3 blinks per 3 seconds: 24VDC output out of spec
 - 4 blinks per 3 seconds: Exceeding -25 Deg. C
 - 5 blinks per 3 seconds: Exceeding +75 Deg. C

If more than one alarm is set the LED will cycle through the Blink Rates one at a time, and then repeat until the alarm is cleared.

Note: These Blink Rates include a 3 second alarm delay to prevent triggering a false alarm when the fan ramps up or down.

Dimensions

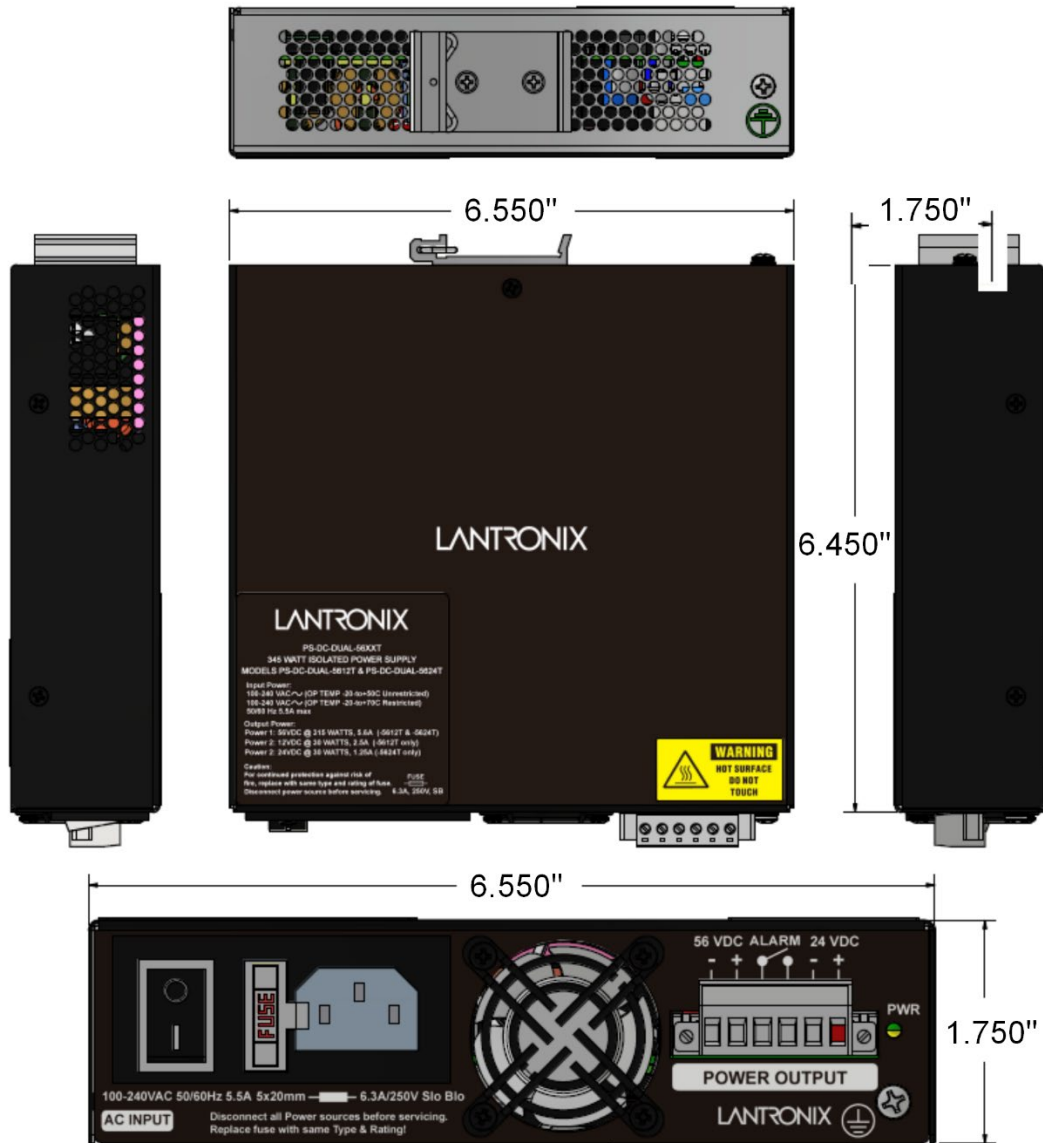

Power Cords

Locking and non-locking line cords are available.

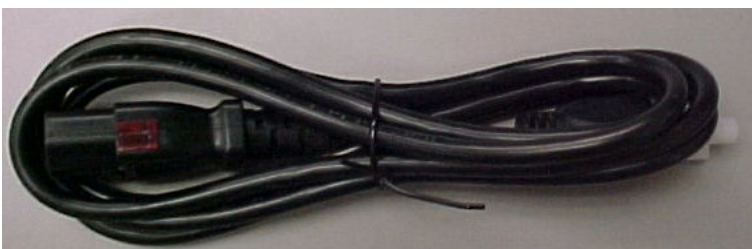

AC Power Cord with locking; -NA Line Cord



AC Power Cord with locking; -NA Line Cord, Right angle

Front Panel Descriptions

The Power Supply front panel is shown and described below. See the Installation section for the actual grounding and connection procedures.



PS-DC-DUAL-5624T Hardened 345 Watt Isolated Power Supply with 56VDC and 24VDC Dual Output



On / Off switch: The power on/power off switch is labeled **O** (off) / **I** (on).

FUSE: The fuse can be replaced without opening the chassis; see [Fuse Replacement](#) below.

AC INPUT Power connection: labeled 100-240VAC 50/60 Hz; see [Connecting AC INPUT](#) below.

POWER OUTPUT Terminal Block: labeled 56 VDC - and +, ALARM, and 24 VDC - and +. See [Connecting POWER OUTPUT](#) below.

PWR (Power) Status LED: a bi-color green/amber LED; Green = OK, Yellow blink = Fault Event Detected (see [LED Blink Rate](#) above).

Ground screw ( ): a Phillips head screw is provided on the front and back panel. See [Grounding](#) below.

2 Installation

Cautions and Warnings

Cautions and Warnings appear here and may appear throughout this manual where appropriate. Failure to read and understand the information identified by this symbol could result in poor equipment performance, damage to the equipment, or injury to persons.

Cautions indicate that there is the possibility of poor equipment performance or potential damage to the equipment. Warnings indicate that there is the possibility of injury to person.

See [Electrical Safety Warnings](#) on page 16 for Electrical Safety Warnings translated into multiple languages.

High Risk Activities Disclaimer: Components, units, or third-party products used in the product described herein are NOT fault-tolerant and are NOT designed, manufactured, or intended for use as on-line control equipment in the following hazardous environments requiring fail-safe controls: the operation of Nuclear Facilities, Aircraft Navigation or Aircraft Communication Systems, Air Traffic Control, Life Support, or Weapons Systems ("High Risk Activities"). Lantronix and its supplier(s) specifically disclaim any expressed or implied warranty of fitness for such High Risk Activities.

Notice: Not Designed for Use in Life Support Equipment or Applications: These products are not designed for use in life support equipment or applications that would cause a life-threatening situation if any such product failed. Do not use this product in these types of equipment or applications.

Operating Temperature - RESTRICTED ACCESS LOCATION: A location for equipment where both of the following paragraphs apply:

- access can only be gained by SERVICE PERSONS or by USERS who have been instructed about the reasons for the restriction applied to the location and about any precautions that shall be taken; and
- access is through the use of a TOOL or lock and key, or other means of security, and is controlled by the authority responsible for the location.

NOTE: The requirements for equipment intended for installation in RESTRICTED ACCESS LOCATIONS are the same as for OPERATOR ACCESS AREAS, except as given in 1.7.17, 2.1.3 and 4.5.1.

1.2.7.4 TOOL: A screwdriver or any other object which may be used to operate a screw, latch or similar fixing means.

1.2.7.5 BODY: All accessible conductive parts, shafts of handles, knobs, grips and the like, and metal foil in contact with all accessible surfaces of insulating material.

1.2.7.6 SAFETY INTERLOCK: A means either of preventing access to a hazardous area until the hazard is removed, or of automatically removing the hazardous condition when access is gained.

WARNING
HOT SURFACE
DO NOT
TOUCH



Input Power:

100-240 VAC ~ (Operating Temperature -20 to +50°C Unrestricted)

100-240 VAC ~ (Operating Temperature -20 to +70°C Restricted)

50/60 Hz 5.5A max

Output Power:

Power 1: 56VDC @ 315 Watts, 5.6 Amps

Power 2: 24VDC @ 30 Watts, 1.25 Amps

**Unpacking**

Carefully unpack the Power Supply. Verify you have received the items below. Save the packaging for possible future use.

- One Power Supply
- One Postcard
- One printed Quick Start Guide, 33792
- One AC Power Cord (option)
- Four Rubber Feet
- One Snap-on Ferrite, TN 16210

Mounting

Desktop: You can attach the four adhesive-backed rubber feet to the bottom of the power supply for desktop mounting.

DIN Rail: The power supply ships with a rack DIN rail bracket attached. **Caution:** If mounted in a NEMA rated enclosure, either vertical direction is allowed. In a standard 19" rack, the side holes must face upward. To attach the power supply to a DIN rail:

1. General caution for Thermals: Make sure there is at least 2 inches of open space outside of at least one of the two vented sides. See below.
2. Hang the top of the DIN rail bracket on the DIN rail. **Caution:** The DIN Rail Spring Clip must be facing upwards, as shown below.
3. Click the bottom of the DIN rail bracket onto the DIN rail.

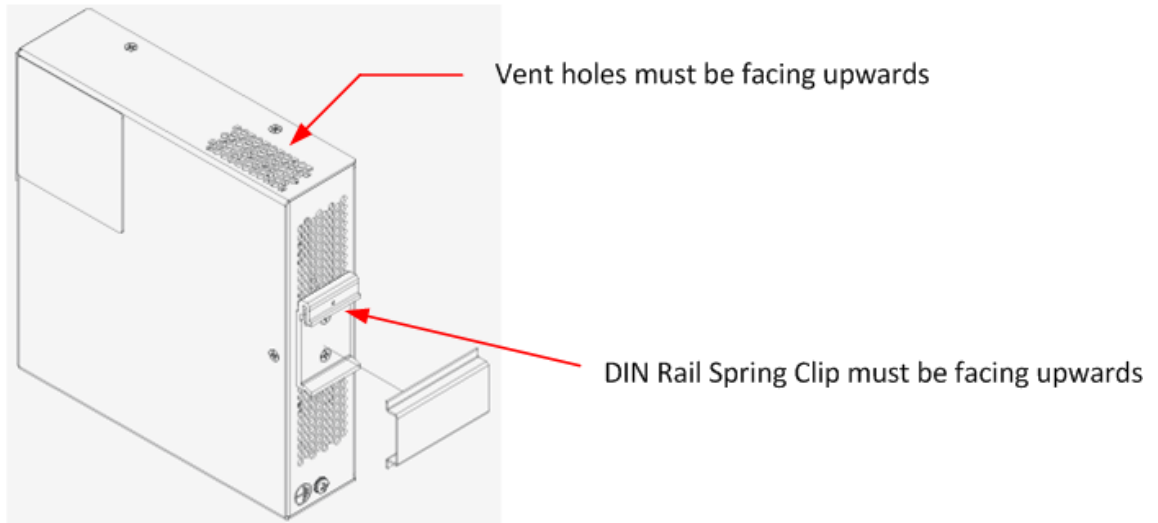

Caution: If mounted in a NEMA rated enclosure, either vertical direction is allowed.



If mounted in a standard 19" rack, the side holes must face upward.

General caution for Thermals: Make sure there is at least 2 inches of open space outside of at least one of the two vented sides.

Caution: The DIN Rail Spring Clip must be facing upwards, as shown below.

Grounding

The front and back panel each provide a grounding screw. Use appropriate gauge wire to connect the Phillips head

Ground screw ( ) to ground following your organization's grounding procedures.

Connecting POWER OUTPUT

Use 14 AWG stranded or better wire (typ.) to connect to 56 VDC@315W.

Use 20 AWG stranded or better wire (typ.) to connect to 24 VDC@30W.

Refer to the powered device documentation for specific connection information; see the [Related Manuals](#) section below.

Connecting AC INPUT

Connect the male end of the provided AC power cord to the power supply AC input first, and then connect the other end to a live 3-prong outlet.

PWR (Power) LED

When the bi-color green/yellow **PWR** LED is lit Green, the power being supplied is OK.

If the bi-color green/yellow LED is blinking yellow, a fan, voltage, or temperature event is occurring.

Fuse Replacement

The AC INPUT is 100-240VAC 50/60Hz 5.5A. The Fuse is a 5x20mm 6.3A/250V SB (slo blo) externally-accessible fuse.

Warning: Disconnect all Power sources before servicing.

Caution: Replace fuse with same Type & Rating!

100-240VAC 50/60Hz 5.5A 5x20mm — 6.3A/250V Slo Blo
AC INPUT Disconnect all Power sources before servicing.
 Replace fuse with same Type & Rating!

Installing TN 16210 Ferrite

For EMC reasons, install Snap-on Ferrite, TN 16210, over the 24 VDC (PS-DC-DUAL-5624T) output wires after installation.

1. Open Ferrite.
2. Place the Ferrite over the 24 VDC Outputs.
3. Snap Ferrite in place.

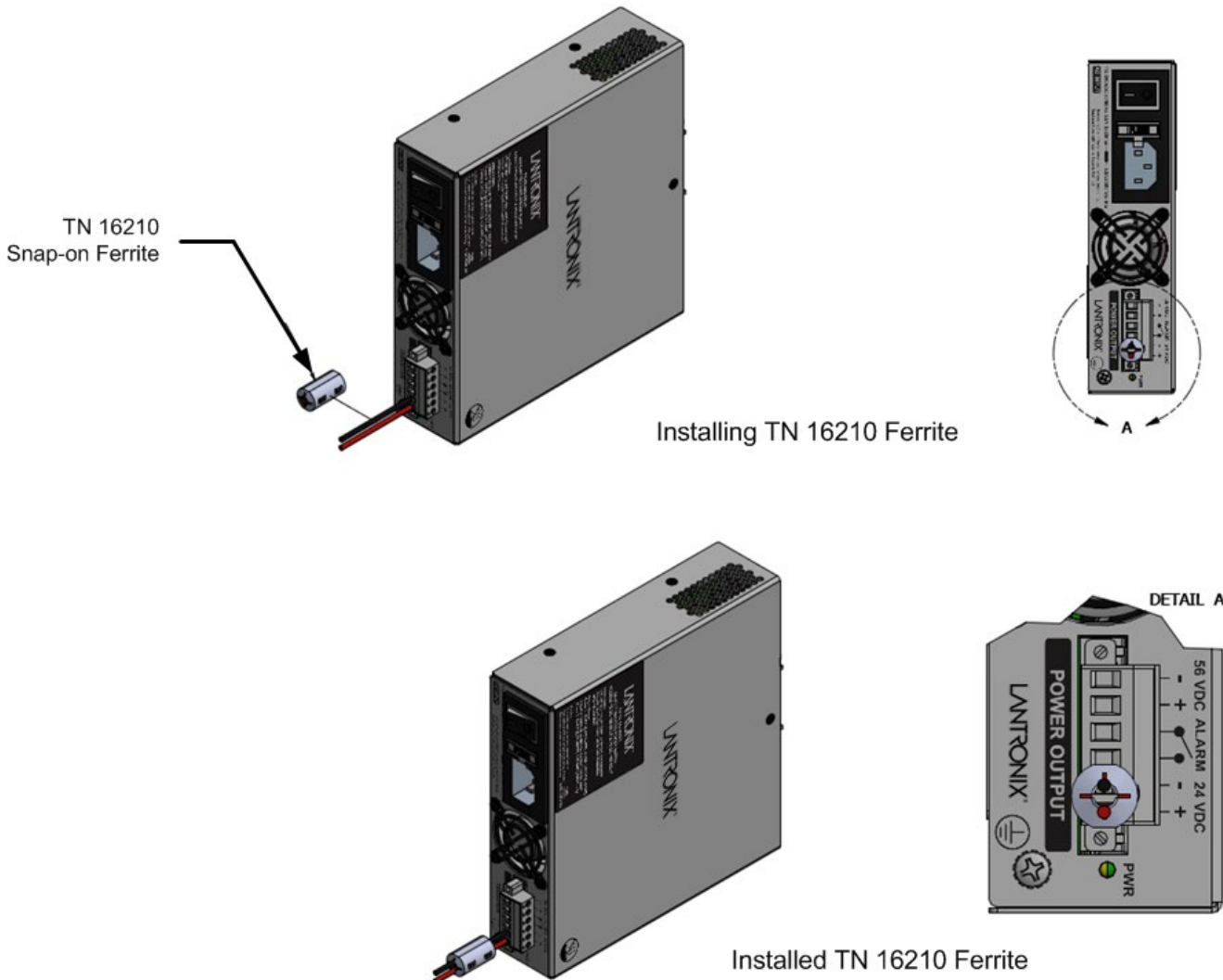

Related Manuals

- PS-DC-DUAL-5624T Power Supply Quick Start Guide, 33792
- Quick Start Guide - SISPM1040-384-LRT-C and SISPM1040-362-LRT, 33726
- Install Guide - SISPM1040-384-LRT-C and SISPM1040-362-LRT, 33727
- Web User Guide - SISPM1040-384-LRT-C and SISPM1040-362-LRT, 33728
- CLI Reference - SISPM1040-384-LRT-C and SISPM1040-362-LRT, 33729

Application Example

The example below shows a SISPM1040-384-LRT-C switch, Enclosure Door sensor, and PS-DC-DUAL-5624T power supply in a single cabinet/enclosure. **Warning:** Ensure that the target alarm input is capable of accepting the applied voltage (24VDC).

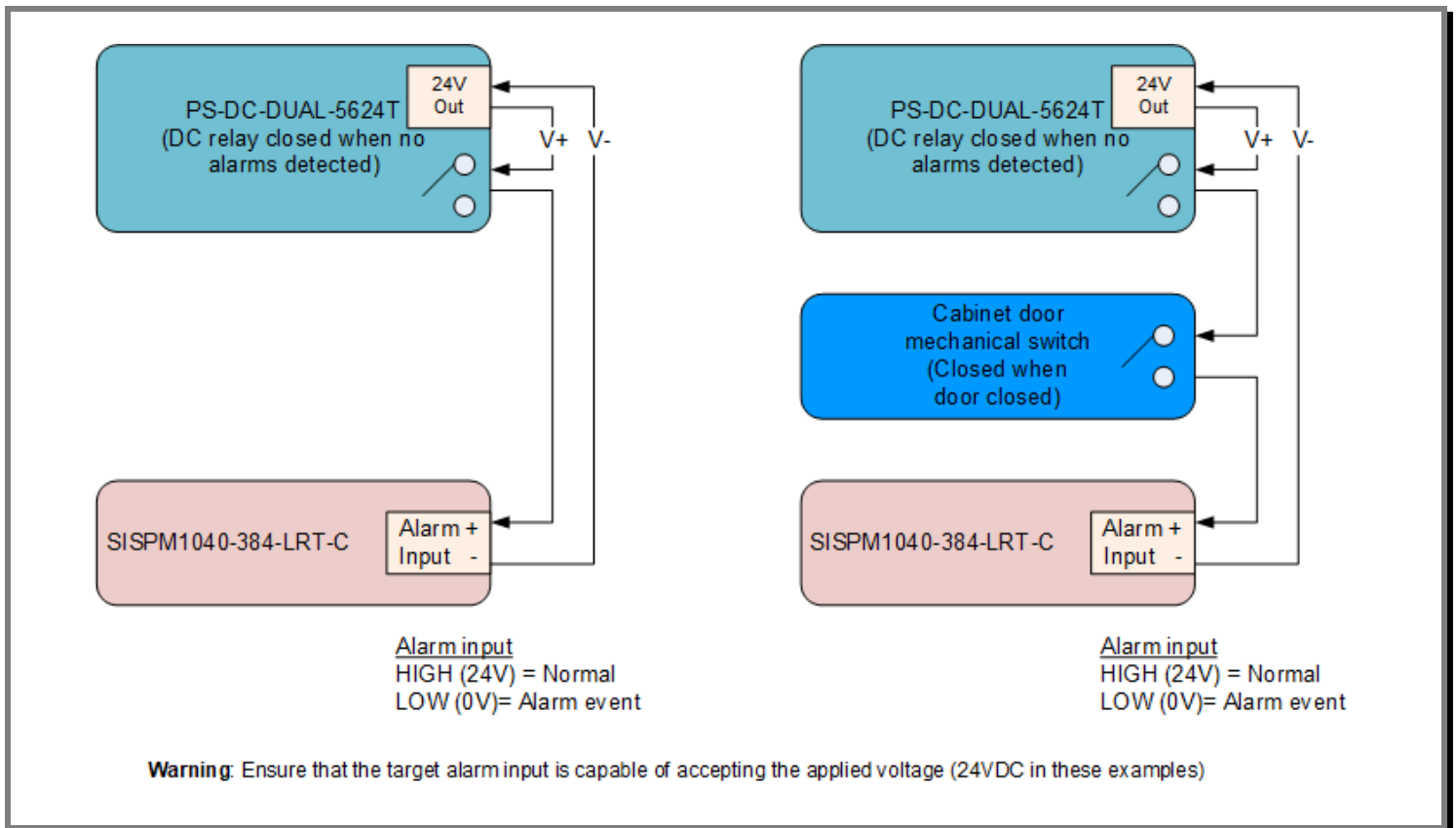

To configure Digital I/O in the SISPM1040-384-LRT-C via the Web UI:

1. Click Configuration > System > Digital I/O.
2. Specify the DI Normal Mode.
3. Enter the desired Normal and Abnormal alarm text to display in Syslog.
4. Click the Apply button.

3 Related Information

Troubleshooting

1. Check the PWR LED for status; see the [PWR \(Power\) LED](#) description on page 15.
2. Check the LED for On or alarm event blinking:
 - a. A short or overload of the 56V will be indicated by no power LED or possibly a quick On/Off cycling.
 - b. A short or overload of the 24V output will be indicated by “24VDC output out of spec” blink rate.
3. Verify the AC power source is good (a live 3-prong outlet).
4. Make sure the fuse is not blown; replace if necessary.
5. Contact Technical Support.

Compliance Information

Declaration of Conformity

Manufacturer's Name: Lantronics, Inc.

Manufacturer's Address: 48 Discovery, Suite 250, Irvine, California 92618

Declares that the products: SISGM1040-284-LRT Hardened Managed Ethernet Switch

Conforms to the following Product Regulations:

FCC Part 15 Class A, EN 55032:2012, EN 55024:2010

Directive 2014/30/EU

Low-Voltage Directive 2014/35/EU

IEC /EN 60950-1:2006+A2:2013

2011/65/EU EN 50581:2012

UL 60950-1

With the technical construction on file at the above address, this product carries the CE Mark

I, the undersigned, hereby declare that the equipment specified above conforms to the above Directive(s) and Standards(s).

Place: Irvine, California

Date: June 23, 2023

Signature: *Eric Bass*

Full Name: Eric Bass

Position: Vice President of Engineering

FCC Regulations

NOTE: This equipment has been tested and found to comply with the limits for a Class A digital device, pursuant to part 15 of the FCC Rules. These limits are designed to provide reasonable protection against harmful interference when the equipment is operated in a commercial environment. This equipment generates, uses, and can radiate radio frequency energy and, if not installed and used in accordance with the instruction manual, may cause harmful interference to radio communications. Operation of this equipment in a residential area is likely to cause harmful interference in which case the user will be required to correct the interference at his own expense.

This device complies with part 15 of the FCC Rules. Operation is subject to the following two conditions: (1) This device may not cause harmful interference, and (2) this device must accept any interference received, including interference that may cause undesired operation.

Electrical Safety Warnings

Electrical Safety

IMPORTANT: This equipment must be installed in accordance with safety precautions.

Elektrische Sicherheit

WICHTIG: Für die Installation dieses Gerätes ist die Einhaltung von Sicherheitsvorkehrungen erforderlich.

Elektrisk sikkerhed

VIGTIG: Dette udstyr skal installeres i overensstemmelse med sikkerhedsadvarslerne.

Elektrische veiligheid

BELANGRIJK: Dit apparaat moet in overeenstemming met de veiligheidsvoorschriften worden geïnstalleerd.

Sécurité électrique

IMPORTANT: Cet équipement doit être utilisé conformément aux instructions de sécurité.

Sähköturvallisuus

TÄRKEÄÄ: Tämä laite on asennettava turvaohjeiden mukaisesti.

Sicurezza elettrica

IMPORTANTE: questa apparecchiatura deve essere installata rispettando le norme di sicurezza.

Elektrisk sikkerhet

VIKTIG: Dette utstyret skal installeres i samsvar med sikkerhetsregler.

Segurança eléctrica

IMPORTANTE: Este equipamento tem que ser instalado segundo as medidas de precaução de segurança.

Seguridad eléctrica

IMPORTANTE: La instalación de este equipo deberá llevarse a cabo cumpliendo con las precauciones de seguridad.

Elsäkerhet

OBS! Alla nödvändiga försiktighetsåtgärder måste vidtas när denna utrustning används.

Product Label and Box Label

You can find device information on the product label and box label. Note: Some Documentation may have Transition Networks named or pictured. Transition Networks was acquired by Lantronix in August 2021.

**Lantronix Corporate Headquarters**

48 Discovery, Suite 250
Irvine, CA 92618, USA
Toll Free: 800-526-8766
Phone: 949-453-3990
Fax: 949-453-3995

Technical Support

Online: <https://www.lantronix.com/technical-support/>

Sales Offices

For a current list of our domestic and international sales offices, go to the Lantronix web site at www.lantronix.com/about/contact.