

NM2-FXS-2230-SFP-01

M.2 100-Base-FX Ethernet Fiber Network Interface Card

Install Guide

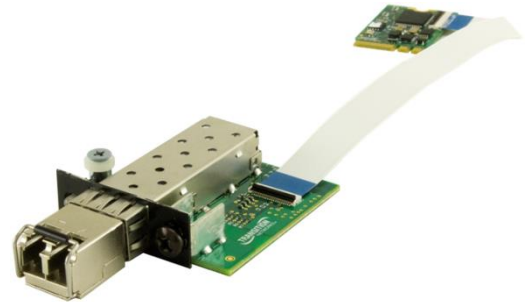

- Ethernet Fiber NIC with 100-Base-FX SFP
- Supports PCI Express M.2 specification
- Installs in Dell OptiPlex™ 7040 and 7050 Micro PCs and Wyse 7000 Series thin clients

Contents

Introduction	1
Ordering Information	2
Features	2
Package Contents	2
M.2 Specifications	3
SFP Specifications	3
System Board Layout	4
NIC Hardware Installation Overview	5
NIC Hardware Location	5
Components Overview	6
Reference Views	6
Pre-Installation Checklist	8
Hardware Installation Procedure	9
PXE Boot Loader from Intel.com	11
Intel i210 PROSet Drivers from Intel.com	11
For More Information	12
Status LED	12
Troubleshooting	12
For More Information	12
Record Device and System Information	13
Contact Us	13
Compliance Information	13
Declaration of Conformity	14
Record of Revisions	14

Introduction

The Transition Networks NM2-FXS-2230-SFP-01 is a 100-Base-FX Ethernet Fiber NIC supporting the PCI Express M.2 specification. It is designed to install in the Dell OptiPlex 7040 and 7050 Micro PCs and the Wyse 7000 Series thin clients.

M.2 is known as the “next generation form factor” and is a specification for internally mounted computer expansion cards and associated connectors. Desktop PCs are being replaced by smaller computing devices (such as Thin Clients, Micro PCs, Ultrabooks, and Tablets) which typically have internal M.2 interfaces but do not have PCI or PCIe slots. Many users still need fiber Ethernet access, and without the external PCIe slot, there is no standard fiber interface on these devices.

See the Dell *OptiPlex 7040M Owner's Manual* for important notes, cautions, and warnings. Read the section “*Before working inside your computer*” before proceeding.

Ordering Information

SKU	Description
NM2-FXS-2230-SFP-01	100-Base-FX Ethernet Fiber NIC with 100-Base-FX to SGMII SFP

Transition Networks M.2 100-Base-FX Ethernet Fiber Network Interface Card (NIC) provides a fiber optic interface for the Dell OptiPlex™ 7040 and 7050 Micro PCs and the Wyse 7000 Series thin clients. The NM2-FXS-2230-SFP-01 consist of a M.2 NIC that installs into the OptiPlex Micro PC’s M.2 “A or E keyed” interface, a fiber optic adapter that installs into the OptiPlex Micro PC’s Option port, a 20-pin Flat Flex Cable (FFC) with right-angle bend connecting the NIC to the fiber adapter, and a 100-Base-FX to SGMII SFP module.

Features

- PCI Express M.2 compliant
- A + E keyed M.2 interface
- Full duplex
- IPv6 capable
- Supports UEFI
- Supports PXE boot
- Jumbo frame support 9014 bytes
- 100Base-FX to SGMII SFP interface
- Flow Control
- Wake on LAN (WOL)
- Smart Load Balancing (SLB)
- TCP Segmentation Offload (TSO)
- Message Signaled Interrupts (MSI)
- Extended Message-Signaled Interrupts (MSI-X)
- LACP support (Teaming)

Package Contents

Verify that you have received the following items. Contact your sales representative if any item is missing. Please save the packaging for possible future use.

- One Media Converter in anti-static pouch.
- One TN-SFP-GE-100FX SFP in anti-static pouch.
- One M.2 NIC PCB attached to FFC Cable in anti-static pouch.
- Parts in a 4x6 baggie (1 each): #4 Flat Head Screw, #4 Nylon Washer, #6 Black SEMS Screw.
- One Documentation Postcard.

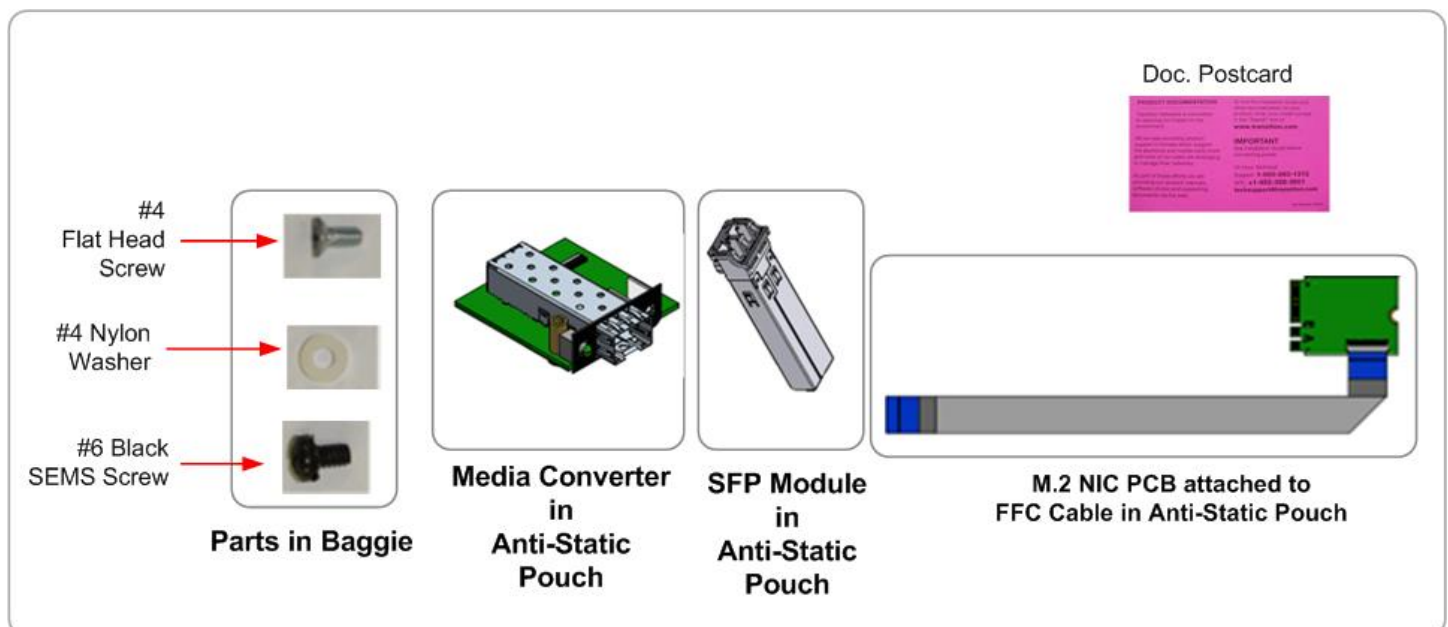

Note that this NM2-FXS-2230-SFP-01 SFP transceiver is sold separately and also as a part of Transition Networks’ NM2-FXS-2230-SFP-01 M.2 100-Base-FX Ethernet Fiber NIC. See the applicable SFP manual for more information on the SFP bundled with the M.2 NIC.

M.2 Specifications

M.2 module naming per specification: 2230-D4-A-E. Key IDs: A and E. Jumbo frame support: 9014 bytes. PXE boot loader image pre-loaded. Uses standard i210 PROSet drivers from Intel. Operating system support: Windows 10 32/64-bit; Windows 8 and 8.1 32/64-bit; Windows 7 32/64-bit; Linux.

Standards	IEEE 802.3-2012
Bus Slot	M.2 - 2230-D4-A-E, Key IDs: A and E.
Data Rate	100 Mbps (FDX only).
Max Frame Size	9014 bytes
Status LED	MC LED 1: Link/Activity LED. LINK/ACT (Amber ON = Link; Flashing = Activity). Color is amber when 100M.

Dimensions:

M.2 NIC:	Width: 0.87" [22 mm] x Depth: 1.19" [30 mm] x Height: 0.12" [3.08 mm].
Fiber Optic Adapter:	Width: 1.65" [42 mm] x Depth: 2.05" [52 mm] x Height: 0.51" [13 mm].
FFC Cable:	Length: 6" [15.3 cm] without right-angle bend; 5.5" [14 cm] with right-angle bend.

Power Consumption	NM2-FXS-2230-SFP-01: 120 mA at 3.3V (0.4 W typical) (not including SFP).
Power Consumption	SFP: 330mA at 3.3V, 1W typical.
Power Source	M.2 interface connector; 3.3V (refer to Table 41 of M.2 specification).
Operating Temp.	0°C to +45°C (+32°F to +113°F).
Storage Temp.	-40°C to +85°C
Humidity	5% to 95% (non-condensing).
Altitude	0 – 10,000 ft.
Weight	0.1 lbs. [0.05 kg]
Compliance	CE Mark; Emissions: EN55032, FCC Part 15; Class A; Immunity: EN55024.
Data Speed:	SFP optic at 100Mbps, full duplex only.
Fiber Port (-SFP):	100Base-X open SFP slot.
DIP Switches / Jumpers:	None
Warranty	Lifetime

SFP Specifications

The TN-SFP-GE-100FX is a Small Form Factor Pluggable (SFP) transceiver compatible with the Multi-Sourcing Agreement (MSA), designed for SGMII MAC interface to 100BASE-FX. The SGMII MAC Interface uses modified 100BASE-X Auto-Negotiation to indicate link, duplex, and speed to the MAC. It data links up to 2km with 50/125um multi mode fiber.

Features include:

- Data Rate (Mbps): 125
- Media: MMF
- Wavelength (nm): 1310
- Transmission Distance(km): 2
- DDMI: Yes



TN-SFP-GE-100FX transceivers support the 2-wire serial communication protocol per the SFP MSA. It is closely related to the E2PROM defined in the GBIC standard, with the same electrical specifications. The standard SFP serial ID provides identification information describing the transceiver’s capabilities, standard interfaces, manufacturer, and other information. The TN-SFP-GE-100FX also provides a Digital Diagnostic Monitoring Interface that allows real-time access to device operating parameters. See the full SFP manual for more details.

System Board Layout

The OptiPlex 7040 Micro has two M.2 expansion slots: one 22x30 slot (#10 in below diagram) and one 22x80 slot (#13 in below diagram). The NM2-FXS-2230-SFP-01 installs in the 22x30 slot (#10 in below diagram). See the *Dell OptiPlex 7040M Owner's Manual* for more details.

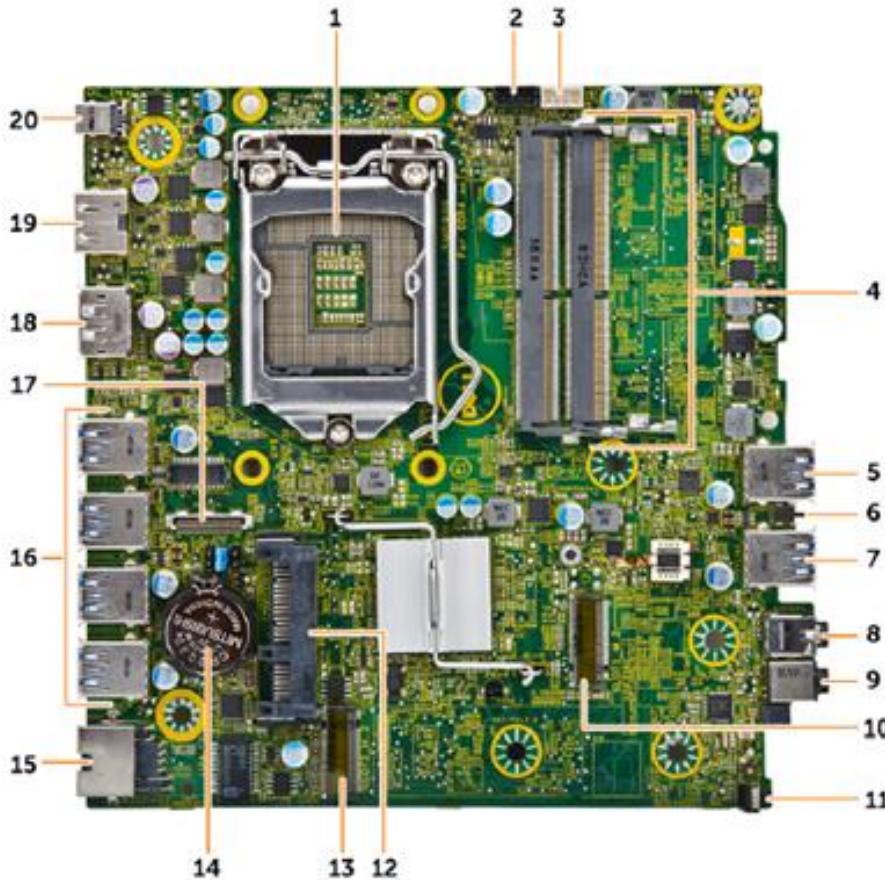

1. Processor	11. Power switch
2. CPU fan connector	12. Hard drive connector
3. Internal speaker connector	13. M.2 socket3 connector
4. Memory module connectors	14. Coin cell battery
5. USB 3.0 connector	15. RJ-45 Ethernet connector
6. Intrusion switch	16. USB 3.0 connector
7. USB 3.0 connector	17. DP/VGA daughter board connector
8. Line out connector	18. DisplayPort connector
9. Universal audio jack	19. HDMI connector
10. M.2 socket1 connector	20. DC-in jack

NIC Hardware Installation Overview

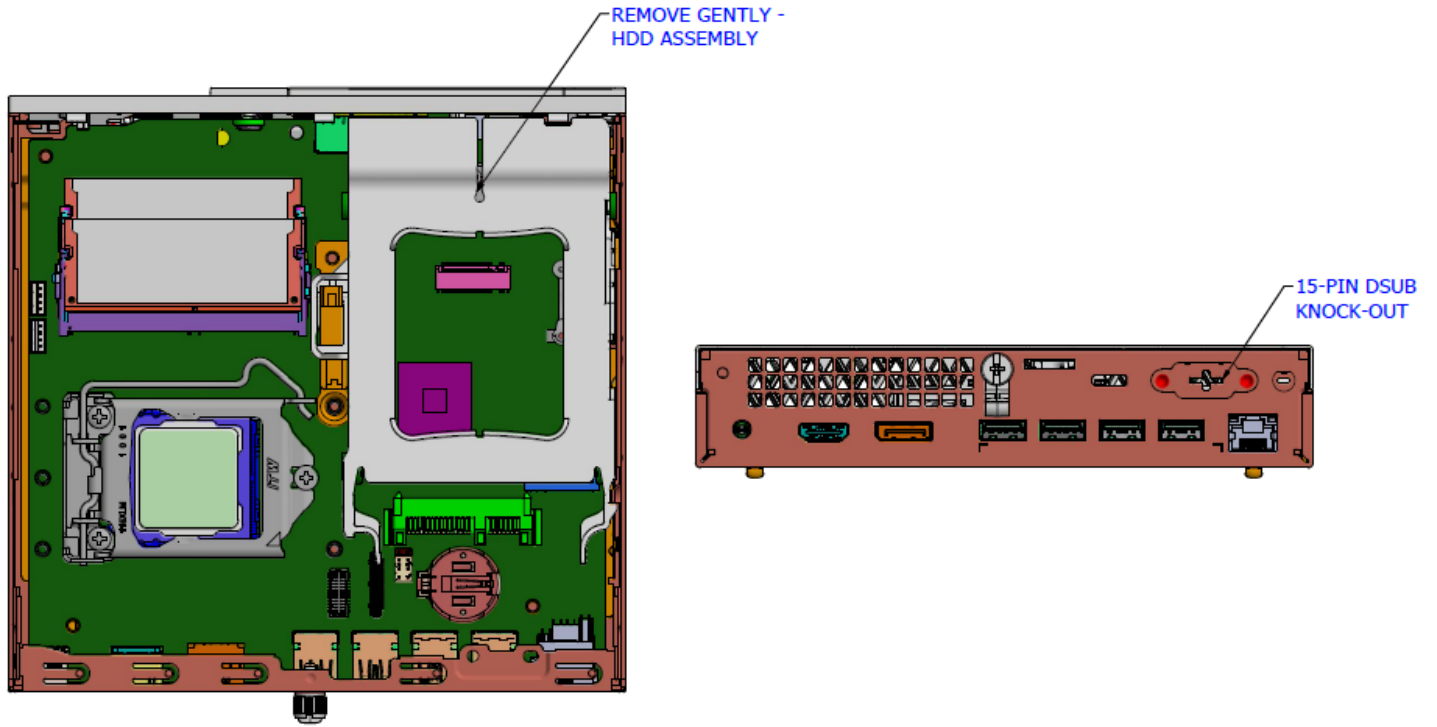

NIC Hardware Location

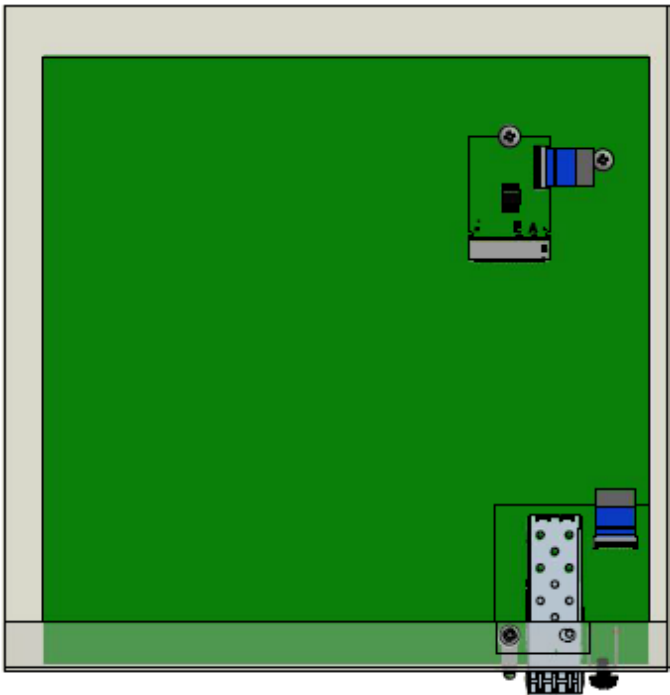

Components Overview

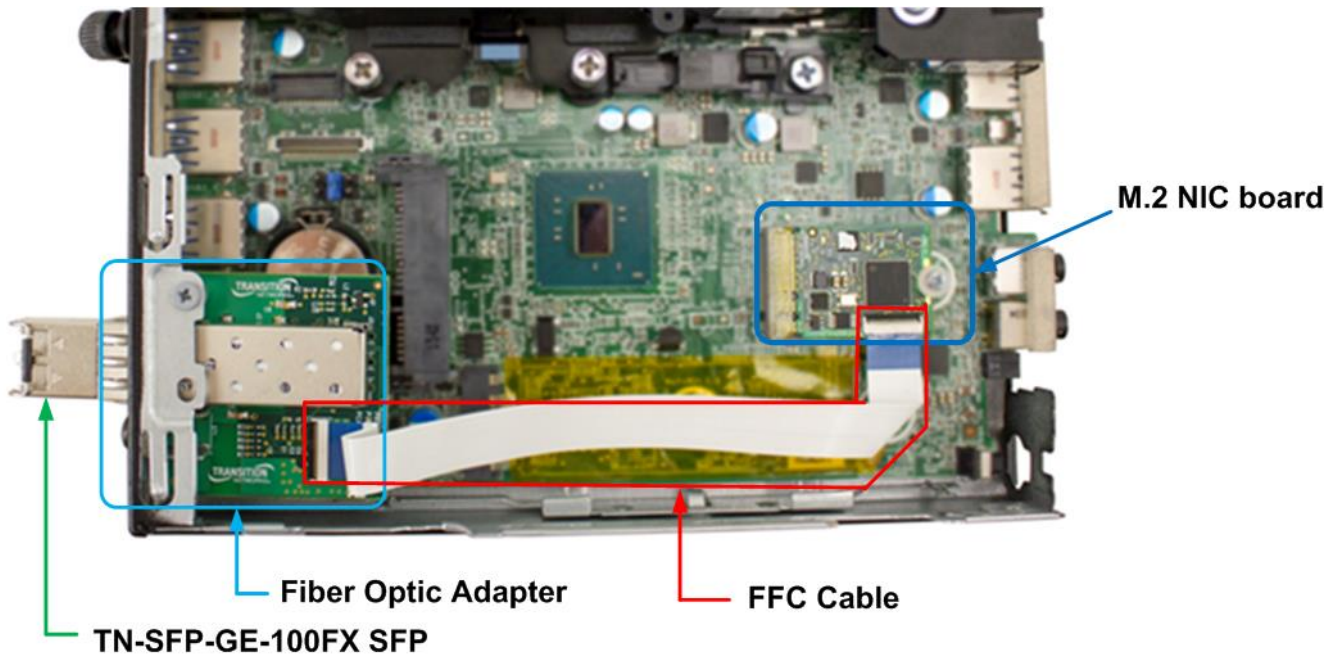

Reference Views





CAUTION: Only qualified persons should install the NIC. Failure to observe this caution could result in poor performance or damage to the equipment. Before installing the NIC, review the Pre-Installation Checklist and Safety Precautions below.

CAUTION: Wear a grounding device and observe electrostatic discharge precautions when installing the NIC in a system. Failure to observe this caution could result in damage to the NIC. Before installing the NIC, review the Pre-Installation Checklist and Safety Precautions below. Before installing the NIC, ensure that system power is OFF, the power cord is unplugged from the power outlet, and that proper electrical grounding procedure has been followed.

WARNING: High voltage inside the system may present a safety hazard. Make sure that the system power is off before removing the cover. Unplug and disconnect the PC and then wait for 15-20 seconds before plugging the NIC into the PC. When removing the NIC, unplug the Ethernet cable before removing the PC cover.

Pre-Installation Checklist

Before installing your NIC, review the preceding sections, and then do the following:

1. Verify that your system is using the latest BIOS.
2. If you download the driver software, record the path where you saved the downloads.
3. If your system is active, shut it down. Do not install the NIC until system power is completely removed. When system shutdown is complete, power OFF and unplug your system.
4. Holding the NIC by the edges, remove it from its shipping package and place it on an antistatic surface.
5. Check the NIC for signs of damage, particularly on the PCB edge connector. **CAUTION:** Never attempt to install a damaged NIC card. If the NIC is damaged, report it to Transition Networks.
6. **CAUTION:** Wear a grounding device and observe electrostatic discharge precautions when installing the NIC in a system. Failure to observe this caution could result in damage to the NIC. Before installing the NIC, ensure that system power is OFF, the power cord is unplugged from the power outlet, and that proper electrical grounding procedures have been followed.
7. **CAUTION:** Install the NIC in an operating environment where the temperature range is from 0°C to +45°C (+32°F to +113 °F), with relative humidity of 5% to 90% non-condensing. Failure to observe this caution could result in poor equipment performance.
8. **CAUTION:** DO NOT install the NIC in areas where strong electromagnetic fields (EMF) exist. Failure to observe this caution could result in poor equipment performance and data corruption.

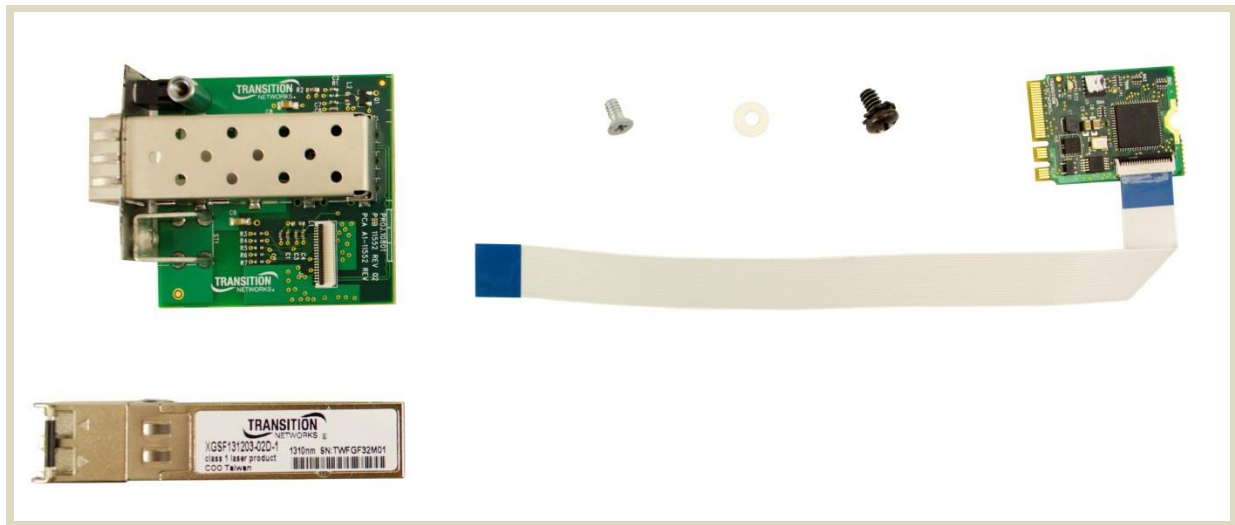

NM2-FXS-2230-SFP-01

9. **Note:** You must install the TN-SFP-GE-100FX in the open SFP slot before you power up the PC.

10. **Class I Laser Compliance:** This product has been tested and found to comply with the limits for FDA Class I laser for IEC60825, EN60825, and 21CFR1040 specifications. **Warning:** Visible and invisible laser radiation when open. DO NOT stare into laser beam or view directly with optical instruments. Failure to observe this warning could result in damage to your eyes or blindness.

Hardware Installation Procedure

1. Remove PC cover.
2. Gently remove the HDD Assembly. See the Dell or Wyse documentation.
3. Remove the 15-Pin DSUB knockout.
4. Install the M.2 NIC Assembly into Motherboard M.2 Edge Connector.
5. Secure the M.2 NIC Assembly into place using the Securing Screw
6. Install the Fiber Optic Adapter into the VGA opening in PC Case, as shown below.
7. Attach to PC Case using Black SEMS Screw #6-32x1/4", and partially tighten to hold in place as shown below.
8. Align #4 Standoff with Top Hole in PC Case.
9. Slip #4 Nylon Washer on top of #4 Standoff and insert #4 Screw to secure.
10. Tighten using Black SEMS Screw #6-32x1/4".

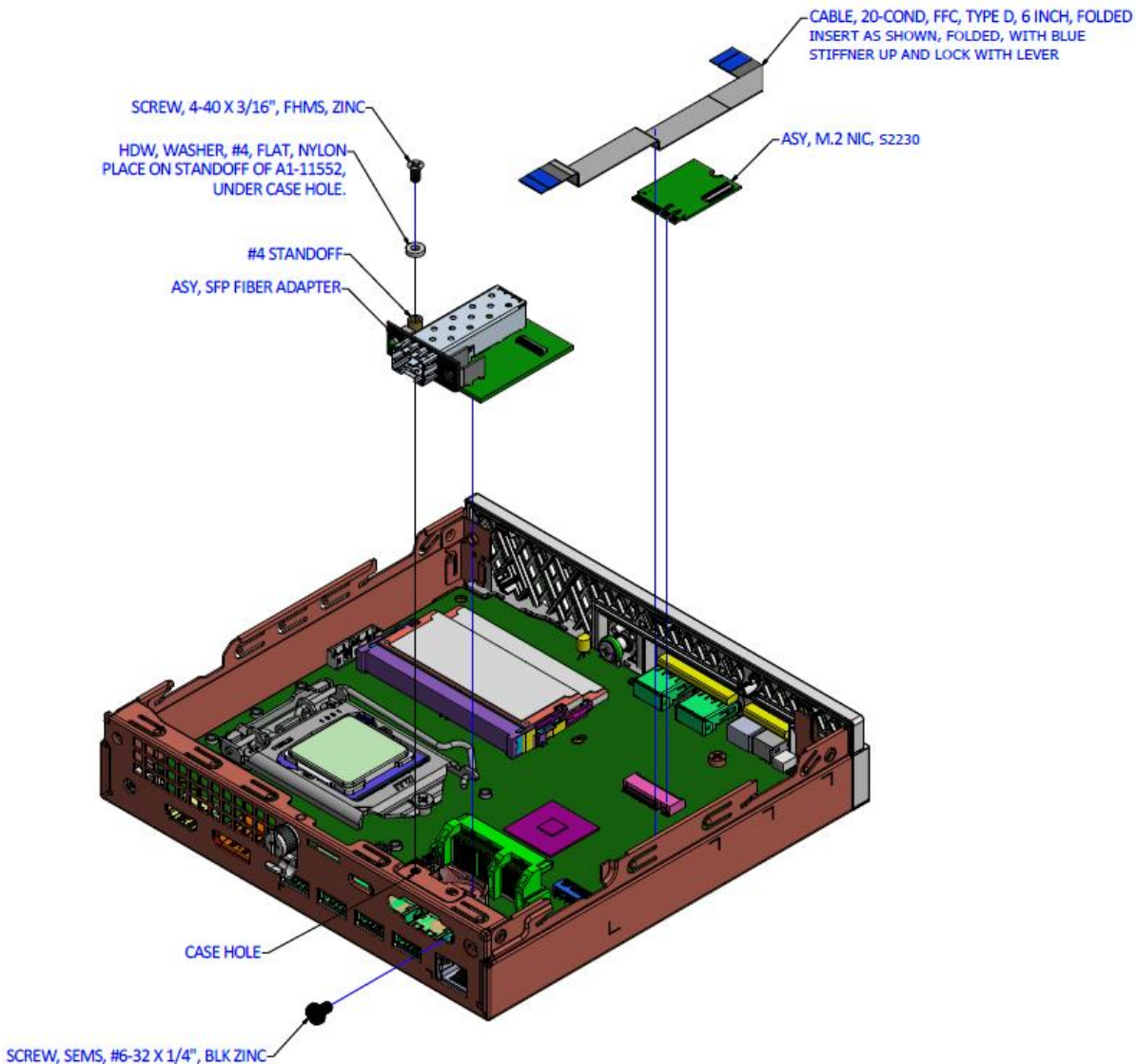

11. Lift Locking Lever of FFC Connector on fiber optic adapter.
12. Insert end of 20-Position FFC Cable into fiber optic adapter, with Pins facing down.
13. Push Locking Lever Down to Lock. Check that Cable is secure. See figure below for final placement.
14. Gently replace the HDD Assembly.
15. Replace PC cover.
16. Install the TN-SFP-GE-100FX in the open SFP slot, and then power up the PC.

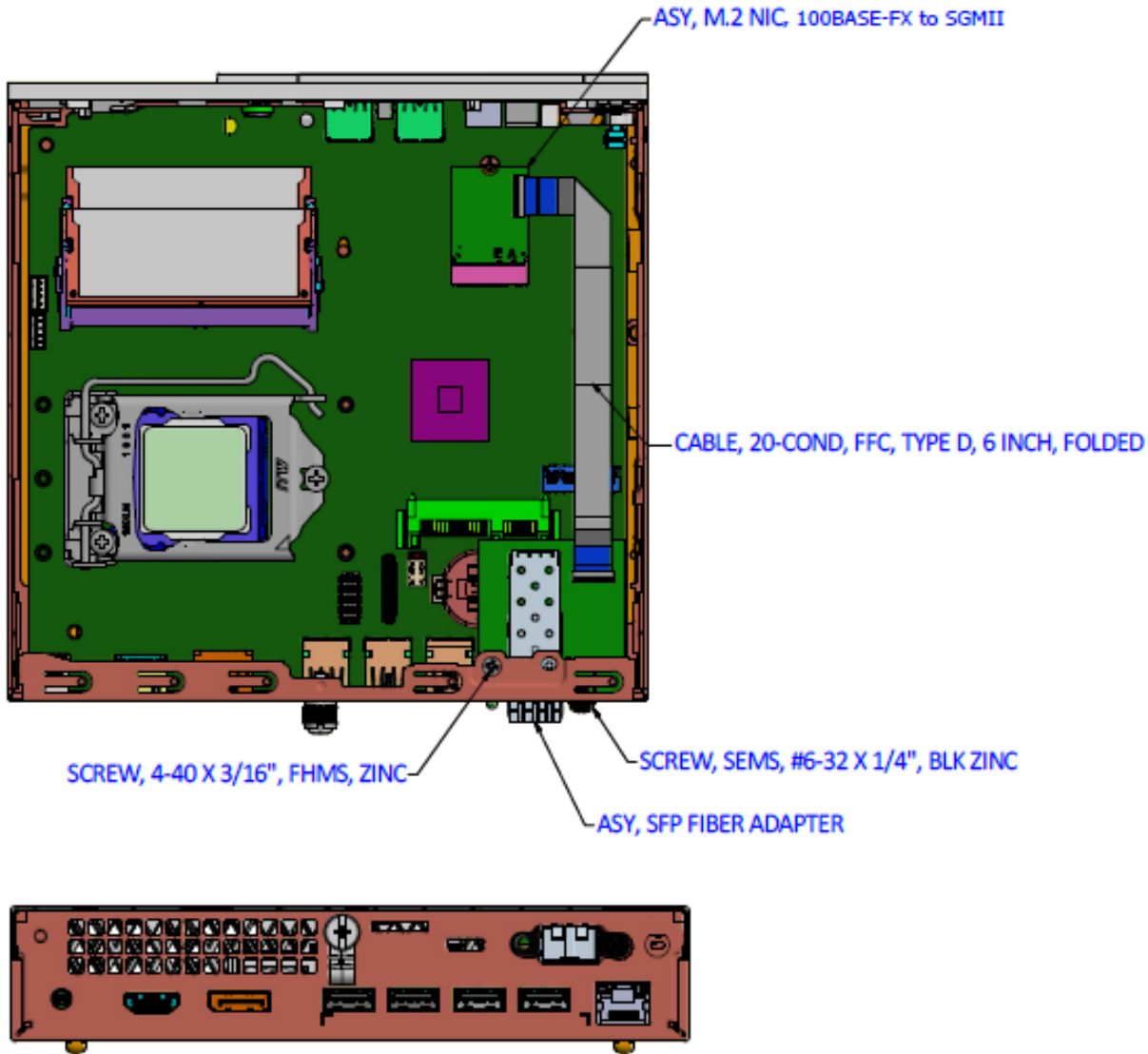

Final Placement

PXE Boot Loader from Intel.com

PXE boot loader image pre-loaded: <https://downloadcenter.intel.com/download/19186/Intel-Ethernet-Connections-Boot-Utility-Preboot-Images-and-EFI-Drivers>.

Intel i210 PROSet Drivers from Intel.com

If your PC does not automatically detect the NM2-FXS-2230-xx-01 NIC, download and install the standard i210 PROSet drivers from Intel at <http://www.intel.com/content/www/us/en/support/network-and-i-o/ethernet-products/000005686.html>.

The Intel® PROSet for Windows* Device Manager is an extension for Windows Device Manager. When you install the Intel PROSet software, tabs are automatically added to the supported Intel adapters in Windows Device Manager. These features allow you to test and configure wired Intel® Ethernet Adapters.

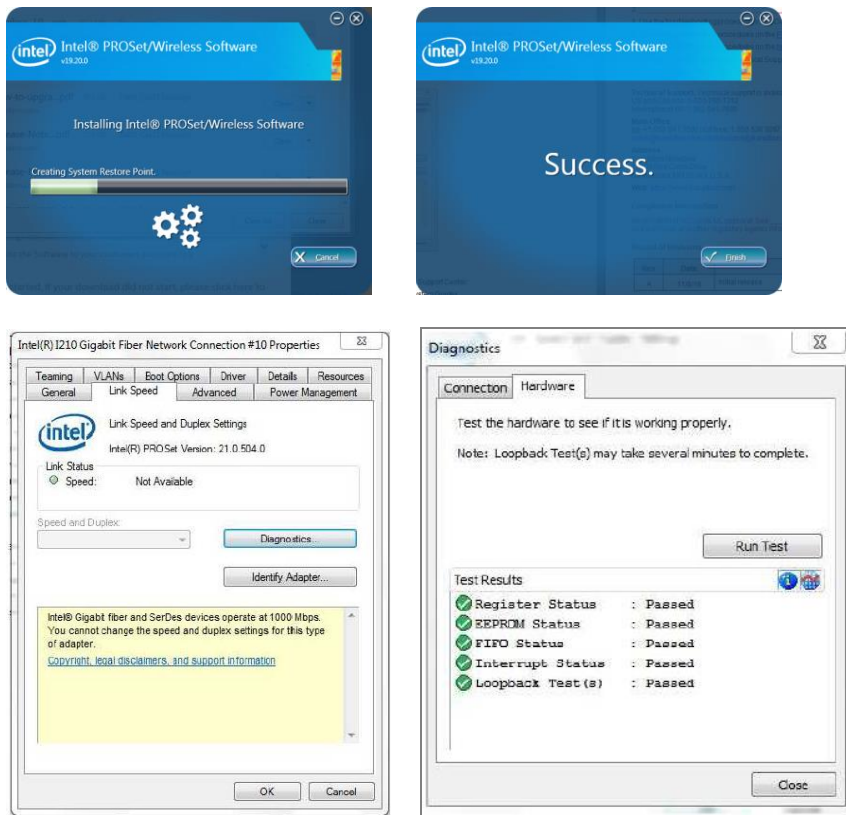

The links below apply to the NM2-FXS-2230-SFP-01. At each link, there is a 32-bit and a 64-bit download for each OS.

- [Intel® Network Adapter Driver for Windows* 7.](#)
- [Intel® Network Adapter Driver for Windows* 8.1.](#)
- [Intel® Network Adapter Driver for Windows® 10.](#)

The full set of [Intel Network Adapter Drivers](#) for download (e.g., for Linux, Windows Server, etc.) is available.

Transition Networks [Resources page](#) has Drivers (ZIP format) for Windows 10 32bit Driver, Windows 10 64bit Driver, Windows 7 32bit Driver, Windows 7 64bit Driver, Windows 8 32bit Driver, and Windows 8 64bit Driver.

For More Information

To view the Dell™ OptiPlex™ User’s Guide at the [Support Center](#) web page:

1. Click Start → Help and Support → Dell User and System Guides → System Guides.
2. Click the User’s Guide for your computer.

The User’s Guide is also available on the optional Drivers and Utilities media.

Support for Wyse 7020 Thin Client is on the [Dell Wyse support page](#).

Status LED

The Media Converter has a status LED for checking Link/Activity.

MC LED 1: Link/Activity LED On = Link; Flashing = Activity. Color is amber when 100M.

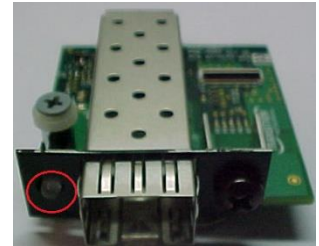

Troubleshooting

This section lists some common problems, their causes, and potential recovery steps.

1. Confirm the [Pre-Installation Checklist](#) items on page 8.
2. Verify the [Hardware Installation Procedure](#) on page 9.
3. Check that the cabling is securely attached. See the [FOA troubleshooting](#) guide or the SFP manual.
4. Check for a mismatch of speed, duplex, protocol, or cable type.
5. Make sure the TN-SFP-GE-100FX is plugged in to the open SFP slot before you power on the PC. Failure to do so will cause the device to fail, in which case you must shut down and restart the PC.
6. Use the troubleshooting procedures in the *Dell™ OptiPlex™ User’s Guide*.
7. Use the troubleshooting procedures on the [PXE Boot Loader webpage](#) as required.
8. Use the troubleshooting procedures on the [Intel i210 PROSet Drivers webpage](#) as required.
9. Verify that the link partner is active and can send/receive traffic; make sure partner settings match; verify that the port is enabled; try connecting to another port or link partner. Check for incompatible or conflicting devices / settings.
10. Run Windows Device Manager and scan for changes.
11. Check if the PC’s BIOS version is appropriate and update to the latest. See the PC documentation.
12. Run the PC diagnostics (e.g., [Dell Quick Test](#) or [Dell pre-boot diagnostics](#)).
13. Automatically detect and update drivers and software if you are connected to the Internet from the computer that needs updated drivers from <http://www.intel.com/support/network/sb/CS-031482.htm>.
14. Record information and contact TN Technical Support. See [Recording Model and System Information](#) below.

For More Information

Technical information in this document is subject to change without notice. See our [SFP Products](#) for more information.

The Fiber Optic Association, Inc. provides a Technical Bulletin on “Guidelines For Testing And Troubleshooting Fiber Optic Installations” at <http://www.thefoa.org/tech/guides/TT3.pdf> Other FOA Technical Bulletins to be used as references for the design and planning of the network can be downloaded from the [FOA Tech Topics website](#).

Record Device and System Information

After performing the troubleshooting steps, and before calling or emailing Technical Support, please record as much information as possible in order to help the TN Tech Support Specialist. Record the following information:

1. Product ID: _____ MAC Address: _____

Serial #: _____ Board Rev: _____

LED status: _____

2. Record the System information: Check your computer documentation for support information.

PC make and model: _____

Operating System: _____

BIOS version: _____

Intel i210 Driver version: _____

PC's Icon Tray indication: _____

Connected Device(s): _____

3. Provide your TN service contract number: _____

4. Describe the failure: _____

5. Describe any action(s) already taken to resolve the problem: _____

Contact Us

Technical Support: Technical support is available 24-hours a day

US and Canada: 1-800-260-1312

International: 00-1-952-941-7600

Main Office

tel: +1.952.941.7600 | toll free: 1.800.526.9267 | fax: 952.941.2322

sales@transition.com | techsupport@transition.com | customerservice@transition.com

Address

Transition Networks
10900 Red Circle Drive
Minnetonka, MN 55343, U.S.A.

Web: <https://www.transition.com>

Compliance Information

EN 55024: 2010. EN 55032: 2012/AC: 2013. AS/NZS CISPR 32: 2013. VCCI V-3/2015.04. ICES-003, Issue 6: 2016
FCC Part 15 Subpart B.

Declaration of Conformity

Declaration of Conformity

Transition Networks, Inc.
Manufacturer's Name

10900 Red Circle Drive, Minnetonka, Minnesota 55343 U.S.A.
Manufacturer's Address

Declares that the products:
NM2-FXS-2230-SFP-01

Conforms to the following Product Regulations:

FCC Part 15 Class A, EN 55032:2012, EN 55024:2010

Directive 2014/30/EU

Low-Voltage Directive 2014/35/EU

IEC /EN 60950-1:2006+A2:2013
2011/65/EU EN 50581:2012

With the technical construction on file at the above address, this product carries the
CE Mark

I, the undersigned, hereby declare that the equipment specified above conforms to the above Directive(s) and Standards(s).

Minnetonka, Minnesota
Place

May 25, 2017
Date

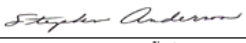

Stephen Anderson
Full Name

Vice President of Engineering
Position

25141B

Modification of NIC voids regulatory agency compliance. See packaging for DoC, FCC, Canadian, and European regulations and warnings, and other regulatory agency information.

High Risk Activities Disclaimer: Components, units, or third-party products used in the product described herein are NOT fault-tolerant and are NOT designed, manufactured, or intended for use as on-line control equipment in the following hazardous environments requiring fail-safe controls: the operation of Nuclear Facilities, Aircraft Navigation or Aircraft Communication Systems, Air Traffic Control, Life Support, or Weapons Systems ("High Risk Activities"). Transition Networks and its supplier(s) specifically disclaim any expressed or implied warranty of fitness for such High Risk Activities.

Record of Revisions

Rev	Date	Notes
A	6/2/17	Initial release for production.
B	12/8/17	Update driver information.
C	9/1/20	Update features.

Trademark notice: All trademarks and registered trademarks are the property of their respective owners.

Copyright restrictions: © 2017-2020 Transition Networks. All rights reserved. No part of this work may be reproduced or used in any form or by any means - graphic, electronic or mechanical - without written permission from Transition Networks.