



SGPAT1040-305



SGPAT1013-105

SGPAT10xx-x05 **Stand-alone Gigabit Ethernet PoE+ Media Converter**

10/100/1000Base-T PoE+ PSE to 1000Base-X

User Guide

Part Number 33719
Revision F October 2024

Intellectual Property

© 2022-2024 Lantronix, Inc. All rights reserved. No part of the contents of this publication may be transmitted or reproduced in any form or by any means without the written permission of Lantronix.

Lantronix is a registered trademark of Lantronix, Inc. in the United States and other countries.

All other trademarks and trade names are the property of their respective holders.

Patented: [Patents | Lantronix](#); additional patents pending.

Warranty

For details on the Lantronix warranty policy, please go to <http://www.lantronix.com/support/warranty>.

Contacts

Lantronix Corporate Headquarters

48 Discovery, Suite 250
Irvine, CA 92618, USA
Toll Free: 800-526-8766
Phone: 949-453-3990
Fax: 949-453-3995

Technical Support

Online: <https://www.lantronix.com/technical-support/>

Sales Offices

For a current list of our domestic and international sales offices, go to www.lantronix.com/about/contact.

Disclaimer

All information contained herein is provided “AS IS.” Lantronix undertakes no obligation to update the information in this publication. Lantronix does not make, and specifically disclaims, all warranties of any kind (express, implied or otherwise) regarding title, non-infringement, fitness, quality, accuracy, completeness, usefulness, suitability or performance of the information provided herein. Lantronix shall have no liability whatsoever to any user for any damages, losses and causes of action (whether in contract or in tort or otherwise) in connection with the user’s access or usage of any of the information or content contained herein. The information and specifications contained in this document are subject to change without notice.

Revision History

Rev	Date	Notes
A	3/29/17	Initial release for SGPAT1013-105.
B	5/16/17	Update DoC and Cisco Blue cable information and power supply art.
C	8/21/17	Update to HW v1 and firmware version B(22). The CLI now displays the version after a parameter change. Clarify Dual Converter mode, Redundant Fiber mode, and Port Isolation operation. Note that APR requires both Dual Converter mode and ALPT mode to be enabled, and that timers must complete before an ALPT event can trigger a power reset.
D	2/14/18	Add Warranty and MTBF data.
E	12/27/22	Initial Lantronix rebrand. Update power supply information.
F	10/17/24	Add TAA and NDAA Compliant and fix typo. Update contact information.

Contents

Revision History	2
1 Introduction and Product Description	5
SGPAT Family Portrait	6
Port Locations and Layouts	7
Specifications	8
Power Consumption	8
Features	9
Hardware Features	10
Dimensions	11
6-Position DIP Switch.....	12
6-Position DIP Switch Model Summary	13
Status LEDs	14
PSE Status LED Error Indicators	14
2 Installation.....	15
Safety Warnings and Cautions.....	15
Unpacking	16
Mounting Options	16
Desktop	16
Wall Mount.....	16
DIN Rail	16
Cabling	17
Installing Copper Cable	17
Installing Fiber Cable.....	17
Powering	18
Power Connection	18
3 Product Features	19
Auto-Negotiation	19
Full-Duplex Network.....	19
Half-Duplex Network (512-Bit Rule).....	19
AutoCross™	19
Automatic Link Restoration	19
Remote Fault Detect (RFD)	20
Auto Power Reset (APR)	20
Active Link Pass Through (ALPT).....	20
Energy Efficient Ethernet (EEE).....	21
3-Port and 4-Port Operation (Redundant Fiber mode, Revertive mode, Port Isolation).....	22
3-Port Model (SGPAT1040-205)	22
3-Port Switch Mode	22
3-Port Redundant Fiber Mode.....	22
4-Port Model (SGPAT1040-305)	23
4-Port Switch Mode	23
4-Port Redundant Fiber Mode.....	23
4-Port Dual-Converter Mode	25

4	CLI Commands	26
	Connecting to the CONSOLE Port	26
	Terminal Emulator Settings	26
	Command Summary	26
	CLI Commands for Setting Advanced Features	28
	Active Link Pass Through (ALPT) (a Command)	28
	CLI DIP Switch Override (c Command).....	29
	Dual (2x) Converter Mode (d Command).....	30
	TP Energy Efficient Ethernet (EEE) Advertisement Mode (e Command)	31
	Flow Control (f Command)	32
	Get PSE Status Report (g Command)	33
	Port Isolation Mode (l Command)	34
	PSE Port Legacy Detect Mode (l Command).....	35
	Complete Configuration Status Report (m Command)	36
	Auto Negotiation (AN) enable for TP ports or AN disable with port forced mode (n Command)	37
	ALPT PD Power Reset (p Command).....	38
	SFP Port Redundancy Mode (r Command)	39
	SFP Port Mode (s Command)	41
	Temperature of Converter (t Command)	43
	Reset to Factory Defaults (x Command).....	43
	Messages	43
5	Troubleshooting	44
	Record System and Device Information	45
6	Power Supply Features and Specifications	46
	Power Supply Specifications.....	46
	Power Supply Dimensions	47
7	Compliance Information	48
	Declaration of Conformity	48
	Trade Agreement Act (TAA) Compliant Products.....	49
	NDAA, RoHS, REACH and WEEE Compliance	49

1 Introduction and Product Description





The SGPAT10xx-105 connects two different types of network segments (Fiber and Copper), while injecting PoE+ power through its copper RJ-45 copper port(s) (up to two supported).

The SGPAT10xx-105 is a 10/100/1000Base-T to 1000Base-SX/LX Gigabit Ethernet Media Converter, which easily and affordably facilitates the connection between to differently cabled network segments, while also injecting PoE+ power through the copper RJ-45 port.

PoE allows for the transmission of power over the same copper cables used to transmit data. PoE+ media converters are Power Sourcing Equipment (PSE). The SGPAT media converter combines data received over a fiber optic link with 56VDC input power to provide power and data to a Powered Device (PD) over twisted pair cabling while complying with the IEEE802.3at PoE+ standard, which is also backwards compatible with the IEEE802.3af PoE standard.

The converter is available in 2-port, 3-port, and 4-port versions and includes PD signature sensing and power monitoring features. Active Link Pass Through (ALPT) is supported, which is an automatically activated version of Link Pass Through (LPT) that allows the converter to detect the loss of Receive (Rx) signals on either fiber or copper port and propagate the failure to the end devices, preventing the media converter from isolating those link failures. During a Link Pass Through event, the Auto Power Reset feature will re-set the power to the end PD device, ensuring it is ready to go when the LPT event is corrected.

Ordering Information / Configurations

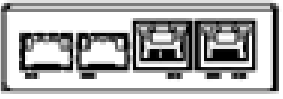
SGPAT1013-105		10/100/1000Base-T PoE+ RJ-45 [100 m/328 ft.] to 1000Base-SX 850nm multimode (SC) [62.5/125um: 220m / 722 ft.] [50/125um:550m / 1804 ft.] Link Budget: 8.5dB
SGPAT1039-105		10/100/1000Base-T PoE+ RJ-45 [100 m/328 ft.] to 1000Base-SX 850nm multimode (LC) [62.5/125um: 220m / 722 ft.] [50/125um:550m / 1804 ft.] Link Budget: 8.0dB
SGPAT1040-105		10/100/1000Base-T PoE+ RJ-45 [100 m/328 ft.] to 100/1000Base-X Open SFP Slot
SGPAT1040-205		(1) 10/100/1000Base-T PoE+ RJ-45 [100 m/328 ft.] to (2) 100/1000Base-X Open SFP Slot
SGPAT1040-305		(2) 10/100/1000Base-T PoE+ RJ-45 [100 m/328 ft.] to (2) 100/1000Base-X Open SFP Slot

Power Supply Included: To order the corresponding country specific power supply, add the extension to the end of the SKU (e.g., SGPAT1013-105-NA = North America; -LA = Latin America).

Optional Accessories (sold separately)

SFP Modules	See the Lantronix SFP webpage for our full line of SFP transceivers.
WMBL	Wall Mount Bracket 4" (102mm)
WMVD	DIN Rail Mount Bracket 5" (127mm)
CABLE-CCC-06	Console Cable - Cisco DB9 to RJ-45 Console Cable, Blue, 6 ft.
RMS19-SA4-02	4-Slot Media Converter Shelf

SGPAT Family Portrait

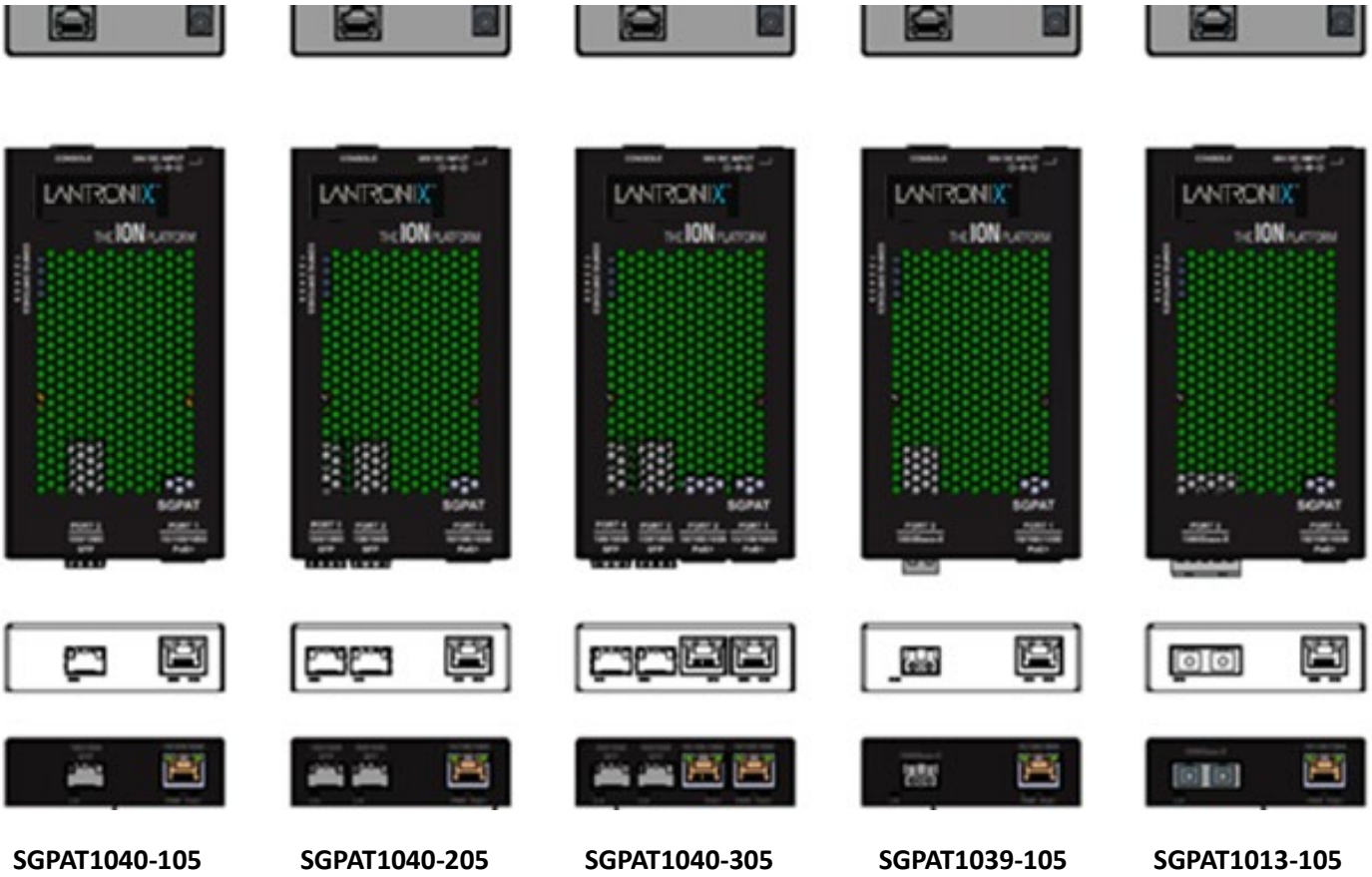

Port Locations and Layouts

Port layouts and locations vary by model number as shown below.

 <p style="text-align: center;">SGPAT1013-105</p>	 <p style="text-align: center;">SGPAT1039-105</p>
 <p style="text-align: center;">SGPAT1040-105</p>	 <p style="text-align: center;">SGPAT1040-205</p>
 <p style="text-align: center;">SGPAT1040-305</p>	

Specifications

The SGPAT10xx-0x5 was designed to meet the specifications below.

Standards	IEEE 802.3-2012, IEEE 802.at PSE-PoE+, IEEE 802.3U, IEEE 802.3ab, IEEE 802.3z, IEEE 802.3x, IEEE 802.3az
Max Packet Size	10240 bytes
Max MAC Addresses	8k
Shared buffer memory	1Mbit
Dimensions	3.25" (82mm) W x 4.8" (122mm) D x 1.0" (25mm) L
Power Source	External AC/DC 56VDC power adapter
Power Consumption	56VDC, 1.17A, 65.5W (assumes both PoE ports are delivering the full 30W). See Power Consumption table below.
Operating Temp.	0 to +45 deg. C (0 to +113 deg. F)
Storage Temp.	-40 to +85 deg. C (-40 to +185 deg. F)
Operating Humidity	5% to 95% (non-condensing)
Altitude	0-10,000 feet
Weight	2lbs. (0.90kg) SGPAT with packaging
Weight	1.55 lbs. (0.7 Kg.) SGPAT
Compliance	EN55022 Class A, EN55024, CE Mark, Power Supply is UL listed; TAA Compliant and NDAA Compliant
Immunity Compliance	EN55024-2010
Safety Compliance	SGPAT: N/A. External AC-DC supply: CE mark, UL Listed.
MTBF	Without power supply: Per MIL-HDBK 217F Parts Stress Method (GB) MTBF = 163000 Hrs. Per Bellcore Parts Stress Method MTBF = 450000 Hrs. With power supply: Per MIL-HDBK 217F Parts Stress Method (GB) MTBF = 42000 Hrs. Per Bellcore Parts Stress Method MTBF = 115000 Hrs.
Warranty	Lifetime

Power Consumption

The table below shows SGPAT power consumption. The table shows SFP models (SGPAT1040-x05) loaded with one or two TN-SFP-SXD (1000Base-SX) SFPs.

Model	Converter Power	PoE Power
SGPAT1013-105	43mA@55.8V (2.3W)	537mA@55.8V (30W)
SGPAT1039-105	43mA@55.8V (2.3W)	537mA@55.8V (30W)
SGPAT1040-105	43mA@55.8V (2.3W)	537mA@55.8V (30W)
SGPAT1040-205	60mA@55.8V (3.4W)	537mA@55.8V (30W)
SGPAT1040-305	80mA@55.6V (4.5W)	1.07A@55.8V (60W)

Features

- Wall mount, DIN Rail, or tabletop installation
- External AC/DC power supply included with country-specific power cord
- 2-port 10/100/1000 copper to fiber media conversion with 802.3at PoE+ on the copper port
- Supports full 30 watts of power to each twisted pair port
- Various fiber versions available supporting fixed SC, fixed LC, and open SFP slots
- 3-port version offers (1) RJ-45 PoE+ port and (2) open SFP slots, device can be configured as a 3-port switch or as a 2-port media converter with redundant fiber links
- 4-port version offers (2) RJ-45 PoE+ ports and (2) open SFP slots, device can be configured as a 4-port switch (with or without redundant fiber) or as two independent PoE+ media converters
- SFP slots can support 100Base-FX, 1000Base-X, or SGMII based (MSA compliant) SFP modules
- Supports Auto-Negotiation, AutoCross, and Active Link Pass Through (ALPT), Auto Power Reset (APR) integrated with ALPT, and Auto Link Restore
- Jumbo frame support
- LED indicators for power status; per port link, duplex, and activity status; and PoE status
- Twisted pair ports support IEEE 802.3az Energy Efficient Ethernet for power saving
- DIP switch control of basic feature configuration
- Command Line Interface (CLI) control of advanced configuration via RJ-45 serial port
- SFP Auto Speed Sensing (in 100/1000 mode) for each port
- Selectable SGMII mode for each fiber port
- Multiport SGPAT versions provide 3-port or 4-port switch mode or provide redundant fiber links with a switchover (failover) time of less than 50 milliseconds
- Revertive or Non-Revertive when in Redundant fiber mode
- Switch mode or 2-Converter mode
- Data speeds: TP @ 10/100/1000Mbps; SFP @100FX/1000X/SGMII; Fixed optic @ 1000X.
- 10/100/1000BaseT Twisted Pair Port: RJ45Connector; Automatic MDI/MDI-X selection; CAT5 UTP Cable specification

Hardware Features

Full bandwidth 1000Mbps switching, non-blocking

4-Port version (SGPAT1040-305) allows enabling 2-Converter mode (two media converter mode)

- Ports 1 and 3 are one converter
- Ports 2 and 4 are another converter
 - Each converter is totally isolated from the other both for data and functions (for example LPT triggering on port 1 will only affect port 3 not port 4)

Active Link-Pass-Through (ALPT)

- Active LPT only operational in specific modes or ports counts; see DIP switch description for details

Interfaces:

- 10/100/1000Mbps TP interface
- 100FX/1000X/SGMII - SFP versions
- 1000X – Fixed optic versions
- Full duplex ONLY on fiber ports

DIP switches to control SFP mode, Fiber redundancy on 2xSFP version, 2-Converter mode on 4xPort version

Jumbo frame support – 10K bytes maximum

TP ports support IEEE 802.3az Energy Efficient Ethernet for power saving

DC option:

- 2-Pin barrel: 52-57VDC
- Must use the provided external AC-DC adapter or you must ensure that the alternate power source meets the IEEE 802.3at isolation requirements

IEEE 802.3at (Power Over Ethernet) PSE

- Provides full 30W of power to each TP port
- Units with LPT capability when enabled will auto-power-reset the POE power when LPT triggers

Temperature rating: 0 to +45 deg. C

RJ-45 serial port for CLI (Command Line Interface), use Cisco blue cable. Console port: RS-232 RJ-45 serial port 115200 baud.

Dimensions

SGPAT dimensions are provided below in inches.

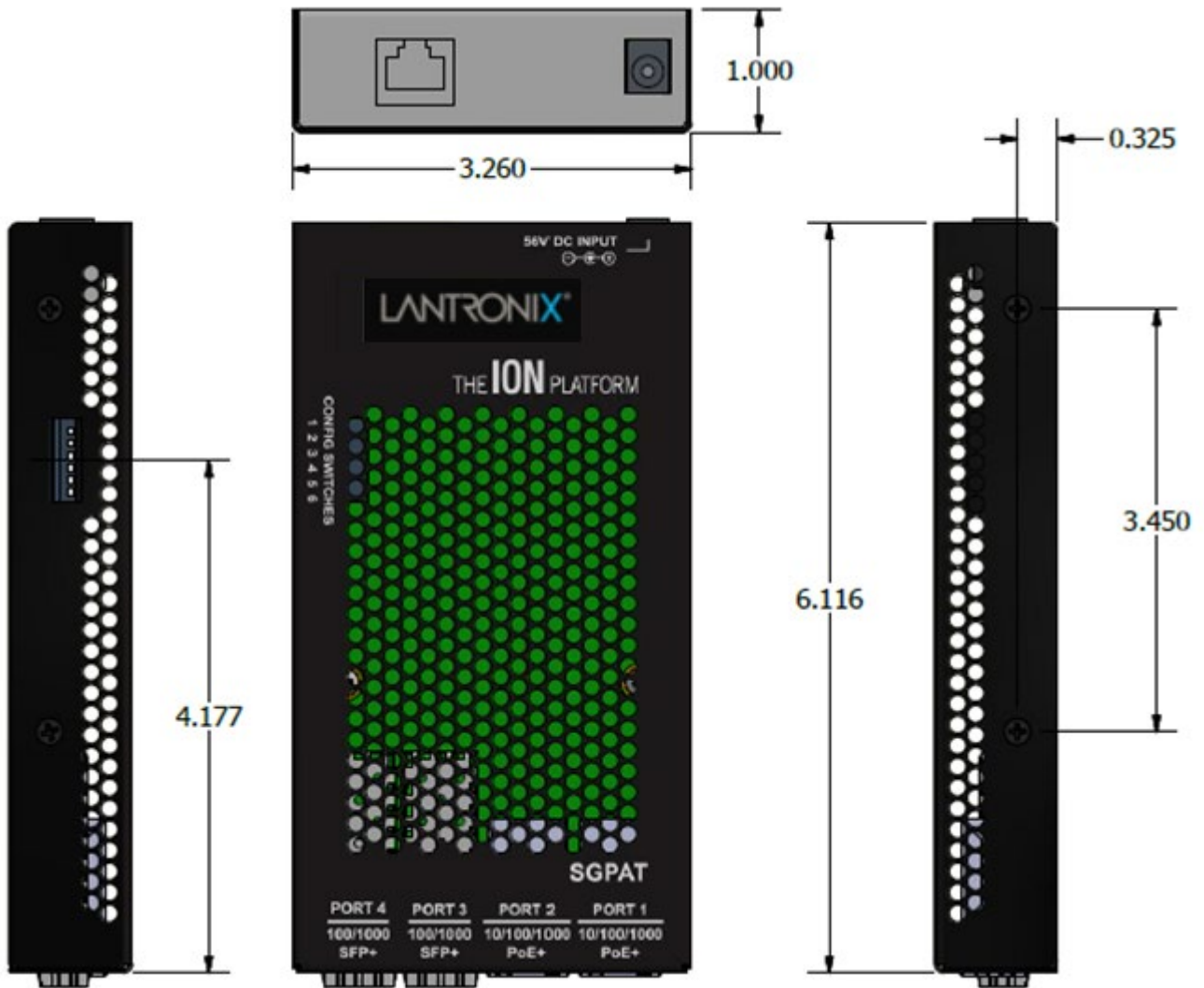

6-Position DIP Switch

A 6-Position DIP Switch is provided for basic SGPAT configuration. The DIP switch default is all in the UP position. The DIP switch default setting is valid until CLI DIP Switch Override is Enabled (which is disabled by default). See [CLI DIP Switch Override \(c Command\)](#) on page 29 for more information.

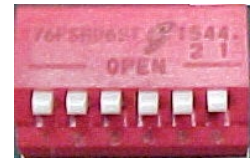

The DIP Switch settings are shown and described below.

Switch 1 Port 3: Up=100/1000 or Down=SGMII

Applies to these versions:

SGPAT1040-105
SGPAT1040-205
SGPAT1040-305

Switch 2 Port 4: Up=100/1000 or Down=SGMII

Applies to these versions:

SGPAT1040-205
SGPAT1040-305

Switch 3 ALPT: Up=Disabled or Down=Enabled

Applies to these versions:

SGPAT1013-105
SGPAT1039-105
SGPAT1040-105
SGPAT1040-205 with DIP Switch 4 down (Redundant mode enabled)
SGPAT1040-305 with DIP Switch 6 down (2-Converter mode enabled)

Switch 4 Redundant mode: Up=Normal or Down=Redundant

Applies to these versions:

SGPAT1040-205
SGPAT1040-305 with DIP Switch 6 Up (2-Converter mode disabled)

Switch 5 Revertive mode: Up=Revertive or Down=Non-revertive

Applies to these versions:

SGPAT1040-205
SGPAT1040-305 with DIP Switch 6 Up (2-Converter mode disabled)

Switch 6 2-Converter mode: Up=Disabled or Down=Enabled

Applies to this version:

SGPAT1040-305

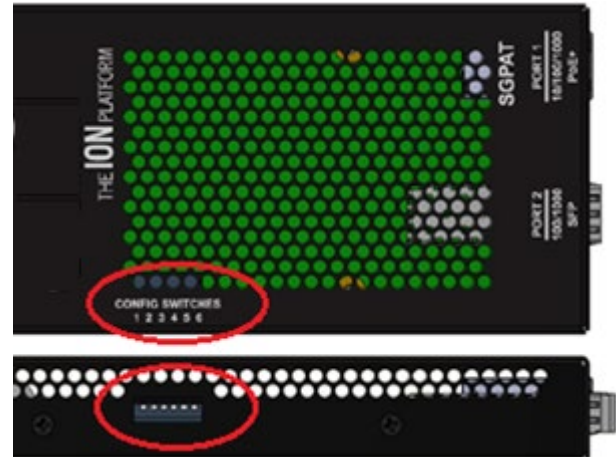

6-Position DIP Switch Model Summary

The DIP switch default is all in the UP position. The DIP switch default setting is valid until CLI DIP Switch Override is Enabled (it is disabled by default). The DIP Switch functions are summarized by model number below.

Model	Description
SGPAT1013-105	DIP SW 1: Reserved DIP SW 2: Reserved DIP SW 3: ALPT: UP=Disabled, DOWN=Enabled DIP SW 4: Reserved DIP SW 5: Reserved DIP SW 6: Reserved
SGPAT1039-105	DIP SW 1: Reserved DIP SW 2: Reserved DIP SW 3: ALPT: UP=Disabled, DOWN=Enabled DIP SW 4: Reserved DIP SW 5: Reserved DIP SW 6: Reserved
SGPAT1040-105	DIP SW 1: Port 2 100/1000 or SGMII mode: UP=100/1000, DOWN=SGMII DIP SW 2: Reserved DIP SW 3: ALPT: UP=Disabled, DOWN=Enabled DIP SW 4: Reserved DIP SW 5: Reserved DIP SW 6: Reserved
SGPAT1040-205	DIP SW 1: Port 2 100/1000 or SGMII mode: UP=100/1000, DOWN=SGMII DIP SW 2: Port 3 100/1000 or SGMII mode: UP=100/1000, DOWN=SGMII DIP SW 3: ALPT: UP=Disabled, DOWN=Enabled* DIP SW 4: Redundant mode: UP=Normal, DOWN=Redundant DIP SW 5: Revertive mode: UP=Revertive, DOWN=Non-Revertive (See Note 1) DIP SW 6: Reserved
SGPAT1040-305	DIP SW 1: Port 3 100/1000 or SGMII mode: UP=100/1000, DOWN=SGMII DIP SW 2: Port 4 100/1000 or SGMII mode: UP=100/1000, DOWN=SGMII DIP SW 3: ALPT: UP=Disabled, DOWN=Enabled (See Note 3) DIP SW 4: Redundant mode: UP=Normal, DOWN=Redundant (See Note 2) DIP SW 5: Revertive mode: UP=Revertive, DOWN=Non-Revertive (See Note 1) DIP SW 6: 2-Converter mode: UP=Disabled, DOWN=Enabled

Note 1: Available only when Redundant mode is active or enabled.

Note 2: Available only when 2-Converter mode is not active or disabled.

Note 3: Available only when 2-Converter mode is active or enabled.

Status LEDs

The SGPAT front panel Status LEDs are shown and described below.

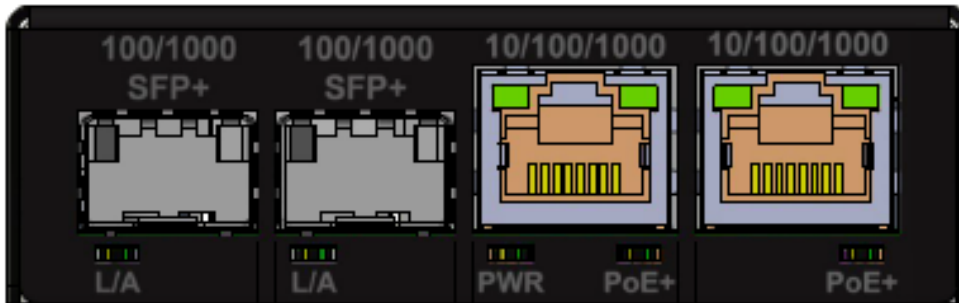

PWR: On = Power being applied to converter

PoE+: Off = No PD detected

On (green) = Power Applied

On (yellow) = Detected Fault

On (yellow Blink) = PoE Classification Fault

TP – Left LED per Port: On (Yellow) = Half Duplex Link

Blink (Yellow) = Half Duplex Activity

On (Green) = Full Duplex Link

Blink (Green) = Full Duplex Activity

TP – Right LED per port: Off = 10Mbps

Yellow = 100Mbps

Green = 1000Mbps

Fiber L/A – per port: 100FX/1000X mode:

On (Yellow) = Link

Blink (Yellow) = Activity

On (Green) = Link

Blink (Green) = Activity

SGMII Mode:

On (Green) = Link

Blink (Green) = Activity

PSE Status LED Error Indicators

1 Blink Yellow = Measured Resistance Signature (Rsig) too Low. End device signature resistance is too low (300 ohm to 15K ohm detected).

2 Blink Yellow = Measured Rsig too High. End device signature resistance is too high (33K ohm to 500K ohm detected).

4 Blink Yellow = Measured Capacitance (Cpd) too High.

5 Blink Yellow = PD Over Current Condition. Power overload fault.

6 Blink Yellow = PD Other error (Power or Time Out error).

2 Installation

Safety Warnings and Cautions

WARNING: Visible and invisible laser radiation when open. Do not stare into the beam or view the beam directly with optical instruments. Failure to observe this warning could result in an eye injury or blindness.

WARNING: Use of controls, adjustments or the performance of procedures other than those specified herein may result in hazardous radiation exposure.

Copper based media ports, e.g., Twisted Pair (TP) Ethernet, USB, RS232, RS422, RS485, DS1, DS3, Video Coax, etc., **are** intended to be connected to intra-building (inside plant) link segments that are not subject to lightning transients or power faults.

Copper based media ports, e.g., Twisted Pair (TP) Ethernet, USB, RS232, RS422, RS485, DS1, DS3, Video Coax, etc., are **NOT** to be connected to inter-building (outside plant) link segments that are subject to lightning transients or power faults.



Warning Class 1 laser product.



Warning Invisible laser radiation may be emitted from disconnected fibers or connectors. Do not stare into beams or view directly with optical instruments.



Warning Use of controls, adjustments, or performing procedures other than those specified may result in hazardous radiation exposure.

Laser safety standards:

- Class 1 LASER PRODUCT (IEC 60825-1 2001-01)
- Class I LASER PRODUCT (complies with 21 CFR 1040.10 and 1040.11 except for deviations pursuant to Laser Notice 50, dated July 26, 2001)

All fiber-optic ports have been tested and comply with the Class 1 limits of IEC 60825-1 and Class I limits of 21 CFR 1040.10.

Waarschuwing Klasse-1 laser produkt.

Varoitus Luokan 1 lasertuote.

Attention Produit laser de classe 1.

Warnung Laserprodukt der Klasse 1.

Avvertenza Prodotto laser di Classe 1.

Advarsel Laserprodukt av klasse 1.

Aviso Produto laser de classe 1.

¡Advertencia! Producto láser Clase I.

Varning! Laserprodukt av klass 1.

Aviso Produto a laser de classe 1.

Advarsel Klasse 1 laserprodukt.

Unpacking

Verify that you have received the following items. Contact your sales representative if any item is missing. Please save the packaging for possible future use.

- One SGPAT10xx-x05 PoE+ Converter
- One Cisco blue cable
- One Documentation Postcard
- Four Rubber Feet
- Power Supply (option – sold separately)

Mounting Options

The SGPAT can be installed by wall mounting, DIN Rail, or tabletop installation.

Desktop

Remove the supplied four Rubber Feet from the adhesive-backed card and install on the bottom of the SGPAT.

Wall Mount

Use the option kit WMBL (4" Wall Mount Bracket) to mount the SGPAT on a wall. See the related manual for mounting specs and instructions.

DIN Rail

Use the option kit WMVD (5" DIN Rail Mount Bracket) to mount the SGPAT on a DIN Rail. See the related manual for mounting specs and instructions.

Cabling

Perform all configuration and cabling before powering the SGPAT.

Installing Copper Cable

1. Locate an Ethernet 10/100/1000Base-TX compliant copper cable with male RJ-45 connectors installed at both ends.
2. Connect the RJ-45 connector at one end of the cable to the SGPAT's Ethernet 10/100/1000Base-RJ-45 port.
3. Connect the RJ-45 connector at the other end of the cable to the Ethernet 10/100/1000Base-RJ-45 port on the other device (IP camera, VOIP phone, WAP, etc.).

Note: The AutoCross feature allows the use of either straight-through or crossover configuration cables.

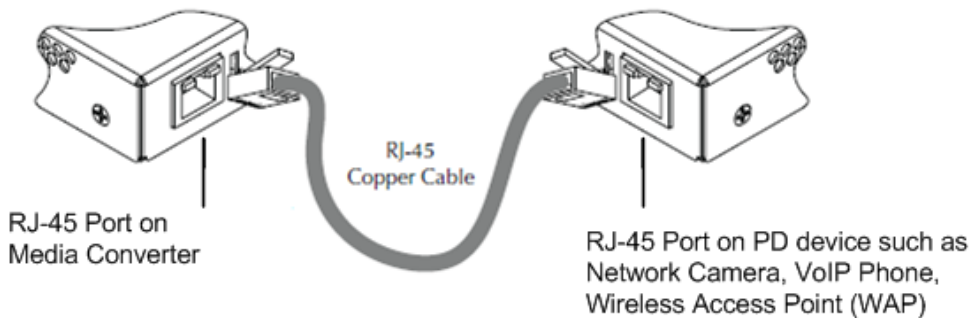

Installing Fiber Cable

1. Locate a 1000Base-X compliant fiber cable with male, two-stranded TX to RX connectors installed at both ends.
2. Connect the fiber cables to the media converter's 1000Base-X fiber port as described below:
 - Connect the male TX cable connector to the female TX connector.
 - Connect the male RX cable connector to the female RX connector.
3. Connect the fiber cables to the 1000Base-X fiber port on the other device (another media converter, hub, etc.) as described below:
 - Connect the male TX cable connector to the female RX connector.
 - Connect the male RX cable connector to the female TX connector.

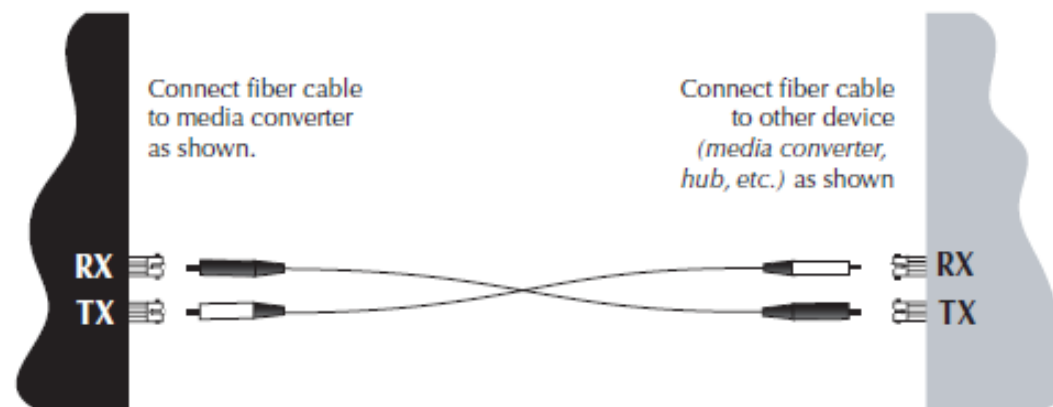

Powering

You must either a) use the provided external AC-DC adapter or b) ensure that the alternate power source meets the IEEE 802.3at isolation requirements. Perform all configuration and cabling before powering the SGPAT.

Power Connection

Use the supplied AC power adapter to power the SGPAT standalone converter. To connect power to the SGPAT:

1. Connect the barrel connector on the power adapter cord to the power connector on the media converter 56VDC INPUT as shown below.



2. Plug the power adapter AC plug into AC power.
3. Verify that the SGPAT has powered UP - the power LED on the front panel is lit.



3 Product Features

The 3-Port model (SGPAT1040-205) provides redundancy / revertive mode operation.

The 4-Port model (SGPAT1040-305) acts like two different converters: a) 4-port switch mode, or b) acts like two media converters in one device.

Applications include a) SGPAT Connected to IP Camera (PD); b) SGPAT Connected to PoE Splitter; and c) Link Pass Through.

Auto-Negotiation

The Auto-Negotiation feature allows the SGPAT10xx to automatically configure itself to achieve the best possible mode of operation over a link. The media converter broadcasts its speed (100 Mb/s, or 1000 Mb/s) and duplex capabilities (full or half) to the other devices and negotiates the best mode of operation. Auto-Negotiation allows quick and easy installation because the optimal link is established automatically. No user intervention is required to determine the best mode of operation.

A scenario where the media converter is linked to a non-negotiating device is a case where you may want to disable Auto-Negotiation. In this instance, the mode of operation will drop to the lowest common denominator between the two devices (e.g. 100 Mb/s, half-duplex). Disabling this feature lets you to force the connection to the best mode of operation.

Note: The SGPAT10xx-13x supports 1000 Mbps fiber Auto-Negotiation.

Full-Duplex Network

In a full-duplex network, maximum cable lengths are determined by the type of cables that are used.

See the cable specifications for the different SGPAT models. The 512-Bit Rule does not apply in a full-duplex network.

Half-Duplex Network (512-Bit Rule)

In a half-duplex network, the maximum cable lengths are determined by the round trip delay limitations of each Fast Ethernet collision domain. (A collision domain is the longest path between any two terminal devices, e.g., a terminal, switch, or router.) The 512-Bit Rule determines the maximum length of cable permitted by calculating the round-trip delay in bit-times (BT) of a particular collision domain. If the result is less than or equal to 512 BT, the path is good.

AutoCross™

The AutoCross feature allows either straight-through (MDI) or crossover (MDI-X) cables to be used when connecting to devices such as hubs, transceivers, or network interface cards (NICs). AutoCross determines the characteristics of the cable connection and automatically configures the unit to link up, regardless of the cable configuration.

Automatic Link Restoration

The SGPAT will automatically restore the link between networked devices after a fault condition has been corrected. In contrast, products from competitors generally require the user to power down, then power up the converters after a fault condition has been corrected.

Remote Fault Detect (RFD)

The RFD feature applies to 1000Mbps operation only. Remote Fault Detect (RFD) is a troubleshooting feature found on Gig Ethernet copper-to-fiber media converters. By enabling RFD on the remotely located media converter, the status of the fiber link will be monitored, and any link failures will be reported back to the local converter. If the remote converter loses its fiber RX signal, RFD will force the converter to shut down its fiber TX port. If Link Pass Through is enabled on both ends, then the copper ports will also be shut down to notify both end devices of the link failure. (With Remote Fault Detect enabled, if the converter only loses an RX Fiber signal, LPT will still notify both linked devices.)

Auto Power Reset (APR)

During an Active Link Pass Through event, the Auto Power Reset feature will re-set the power to the end PD device, ensuring it is ready to go when the LPT event is corrected. When a fiber port loses link, the PoE power will be cycled on the copper (TP) port.

Auto Power Reset requires both Dual Converter mode and ALPT mode to be enabled. Also, there are timers that must complete before a first ALPT event can trigger a power-reset and also before subsequent ALPT events can trigger subsequent power resets. The timers prevent link flapping on devices where the link goes up and down during the boot process.

Active Link Pass Through (ALPT)

Active Link Pass Through (ALPT) is supported, which is an automatically activated version of Link Pass Through (LPT) that allows the converter to detect the loss of Receive (Rx) signals on either fiber or copper port and propagate the failure to the end devices, preventing the media converter from isolating those link failures.

During an ALPT event, the Auto Power Reset feature will re-set the power to the end PD device, ensuring it is ready to go when the ALPT event is corrected.

Note: ALPT is only operational in specific modes or ports counts; see DIP switch description for details).

Link Pass-Through is a troubleshooting feature that allows the media converter to monitor both the fiber and copper RX ports for loss of signal. With the loss of RX signal on one media port, the converter will automatically disable the TX signal of the other media port, thus “passing through” the link loss. With LPT, the end device automatically notified of link loss; this helps prevent loss of valuable data unknowingly transmitted over invalid link.

Active LPT is a form of LPT that requires the links to become Active before LPT becomes Active. ALPT has two states: **Diagnostic** and **Active**. The media converter enters the **Diagnostic** state when either of the following conditions is met:

- Upon power-up of the converter.
- Upon removing the converter’s SFP module (if equipped).

In the **Diagnostic** state, the link for each of the media converter’s ports can come up independently of each other, just like a converter that has no LPT functionality, or a converter that has LPT is disabled. The **Diagnostic** state is helpful during first power up, before all links of a circuit are connected, as it allows the installer to see each link turn on as the cables are plugged in. It’s also helpful for finding the location of a fault, if one exists.

The media converter remains in the **Diagnostic** state until the link status for both of the media converter’s ports are up, simultaneously.

After that condition is met, ALPT enters the **Active** state. It remains in the Active state until the converter is either powered down, or its SFP module is removed. In the Active state, Active LPT works as shown below (the same as when regular LPT is enabled).

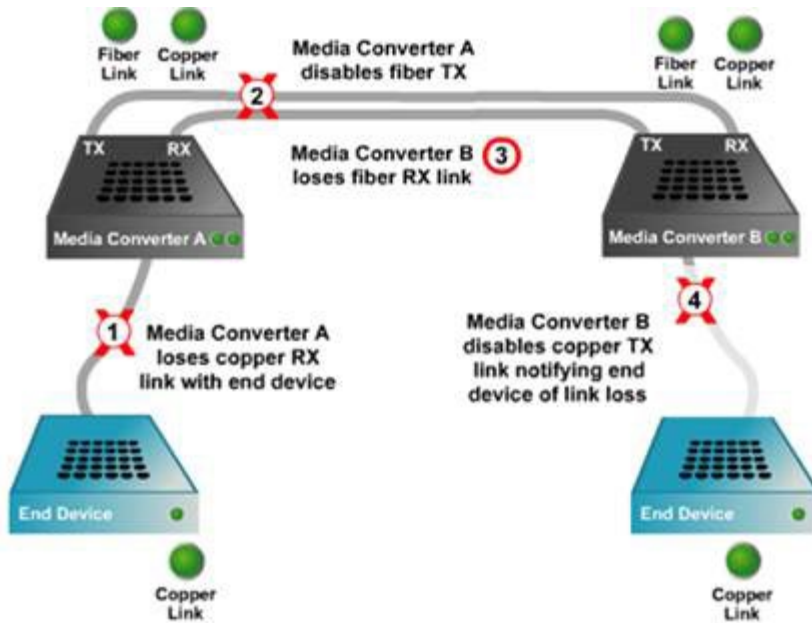

Energy Efficient Ethernet (EEE)

The SGPAT twisted pair ports support IEEE 802.3az Energy Efficient Ethernet for power saving. Energy efficient Ethernet can significantly reduce the power consumption of the device over a period of time especially when there is a large number of idle signals on the copper port. IEEE standard 802.3az which implements a Low Power Idle mode on copper interfaces with internal PHYs. SGPAT TP Ports have the EEE Low Power Idle mode enabled. Note that the Link LED remains lit when in low power mode.

The amount of delay experienced while waiting for the copper interfaces to wake up and come out of low power idle mode is determined by the speed of the port:

$$\text{Delay} = \text{ASSERT TIME} + \text{WAKE TIME}$$

For 1000 Base, delay = 0 + 17us = 17us. For 100 Base, delay = 0 + 30us = 30us.

EEE Low Power Idle mode requires the copper port to advertise via the auto negotiation registers the ability to support EEE for both 1000Base-T and 100Base-T. Both local and remote ports must indicate they can support low power idle mode before the port can initiate a low power idle state.

During Auto-Negotiation the Port EEE capabilities are exchanged using the next page process to establish the speed and duplex information. Timer information with regards to tx_idle, assert and wake cycles are set in SGPAT registers by the CPU. When a port egress queue remains empty for a specific period of time set by the EEE TX_IDLE Timer register, then a low power state can be entered. The default setting for the TX_IDLE is 2 milliseconds.

After the TX_IDLE time the PHY will start the assert timer. The Assert timer will require the SGPAT to wait until the assert timer is zero before a wake up request can be processed. Currently the default Assert timer is set to 0, giving the PHY the ability to immediately start processing a request to leave the low power idle state. The PHY then enters low power idle mode. This mode is defined by a 22.35 millisecond quiet period followed by a 210 microsecond refresh pulse. Then once a port sends a packet and the egress queue is no longer empty a wake up period is needed for the PHY to return to full operation. The default wake times are set to 17 microseconds for 1000Base and 30 microseconds for 100Base. During this wakeup time the packet will continue to buffer in the egress queue until the wake up timer has completed at this point port traffic will begin to flow as normal.

The SGPAT can also support a reduced power mode for 10Base-T in which it modifies the copper media transmit waveform to achieve power consumption savings.

3-Port and 4-Port Operation (Redundant Fiber mode, Revertive mode, Port Isolation)

Multiport SGPAT versions provide 3-port or 4-port switch functionality or provide redundant fiber links, with a switchover (failover) time of less than 50 milliseconds. In Revertive mode, after the failed link is recovered, it becomes the active link again (reverts back to the original link). In Non-revertive mode, after the failed link is recovered, the failed link does not become active again until the currently active link fails.

3-Port Model (SGPAT1040-205)

The 3-port model can be configured as a 3-port switch or as a 2-port media converter with redundant fiber links. The 3-Port model (SGPAT1040-205) operates in 3-Port Switch mode and in Redundant Fiber mode as described below.

3-Port Switch Mode

In 3-Port Switch mode, the SGPAT1040-205 functions as a 3-port switch with 1 copper RJ45 port and 2 fiber ports.

3-Port Redundant Fiber Mode

The SGPAT1040-205 can be configured as a 2-port media converter with redundant fiber links. The figure below shows a 3-port SGPAT1040-205 configured as a 2-port Media Converter with redundant fiber links.

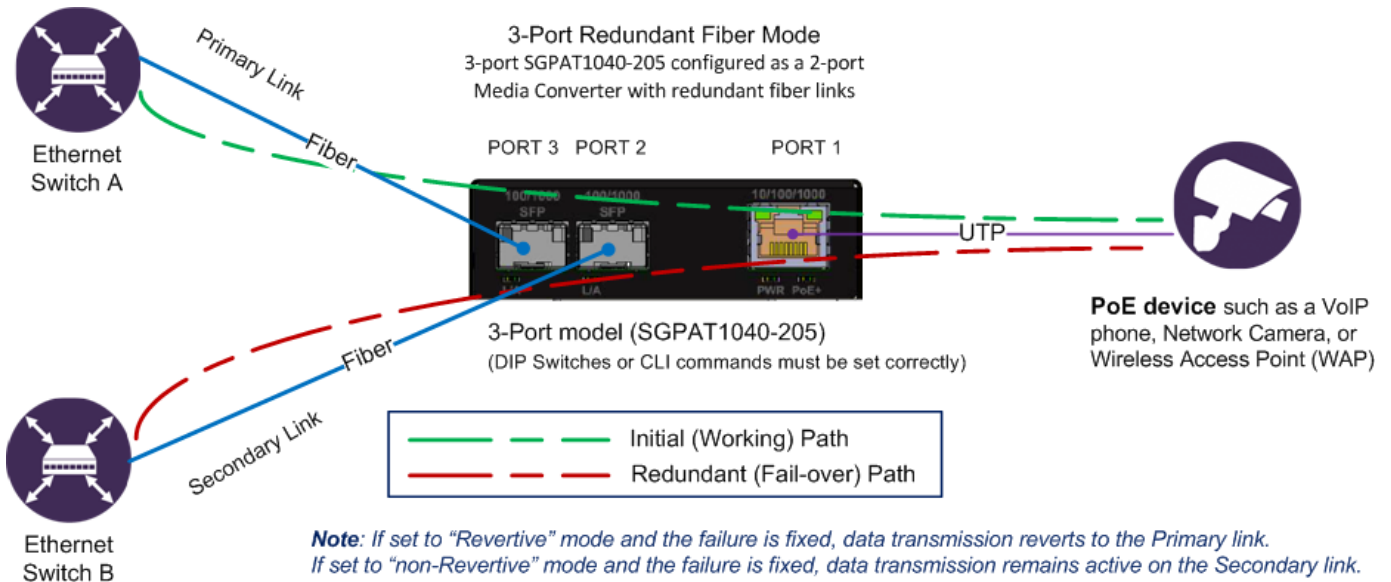

3-Port Redundant Fiber Mode Example

Port Isolation: the 3-Port SGPAT1040-205 supports Port Isolation. This function disables the data paths between ports, but allows the ports to be able to individually communicate with the Active SFP port.

On the 3-port SGPAT1040-205, Redundancy must be disabled for Port Isolation to work. Port isolation can only be enabled via the CLI; see section 4. [CLI Commands](#) on page 29. Traffic ingress on Port 1 will pass data on Port 2 or Port 3. Port 1 will pass data on Port 2 and Port 3, but data cannot be passed between Ports 2 and 3. Port Isolation on 3-port converters is as shown below.

Port	Port Traffic Forwarded To Port(s)
3 (Fiber)	1
2 (Fiber)	1
1 (TP)	2 and 3

4-Port Model (SGPAT1040-305)

The 4-port model (SGPAT1040-305) can be configured as a 4-port switch, as a 3-port switch with Redundant fiber, or as two independent PoE+ media converters (Dual Converter mode).

4-Port Switch Mode

In 4-Port Switch mode, the SGPAT1040-305 functions as a 4-port switch with two copper RJ45 ports and two fiber ports.

4-Port Redundant Fiber Mode

With Redundant Fiber mode enabled, the SGPAT1040-305 Redundant mode can be set to:

- Enabled-Revertive, without Port Isolation
- Enabled-Revertive, with Port Isolation
- Enabled-non-Revertive, without Port Isolation
- Enabled-non-Revertive, with Port Isolation

When Redundant Mode is enabled:

- The links for all 4 ports can come up. Both TP ports are always active, but only one of the two SFP ports can be active at any given time. Port 3 is the Primary SFP port, and Port 4 is the Secondary SFP port.
- Upon power-up, if Port 3's link is up, data will be directed to Port 3 and restricted from Port 4. If Port 3's link goes down, data will be directed from Port 3 to Port 4 with a sub-50ms failover time. At this point, if Port 3's failed link is restored:
 - With Revertive mode enabled, Port 3 will become active again, causing a sub-50ms failover period for the switchover from Port 4 to Port 3.
 - With Revertive mode disabled, Port 4 will remain active until its link goes down, at which point the switch will failover to Port 3 with a sub-50ms failover.
- If Port Isolation is enabled, Ports 1 and 2 will be isolated from each other, but individually able to communicate with the Active SFP port. Port Isolation can only be enabled via the Command Line Interface (CLI); see page 29 for CLI information.
- You can tell whether Port 3 or Port 4 is active by looking at the Activity LEDs (flashing indicates data transfer, and that only occurs on the Active port).

The figure below shows a 4-port SGPAT1040-305 configured in Redundant Fiber mode, where only 3 of the 4 ports can be active at a time.

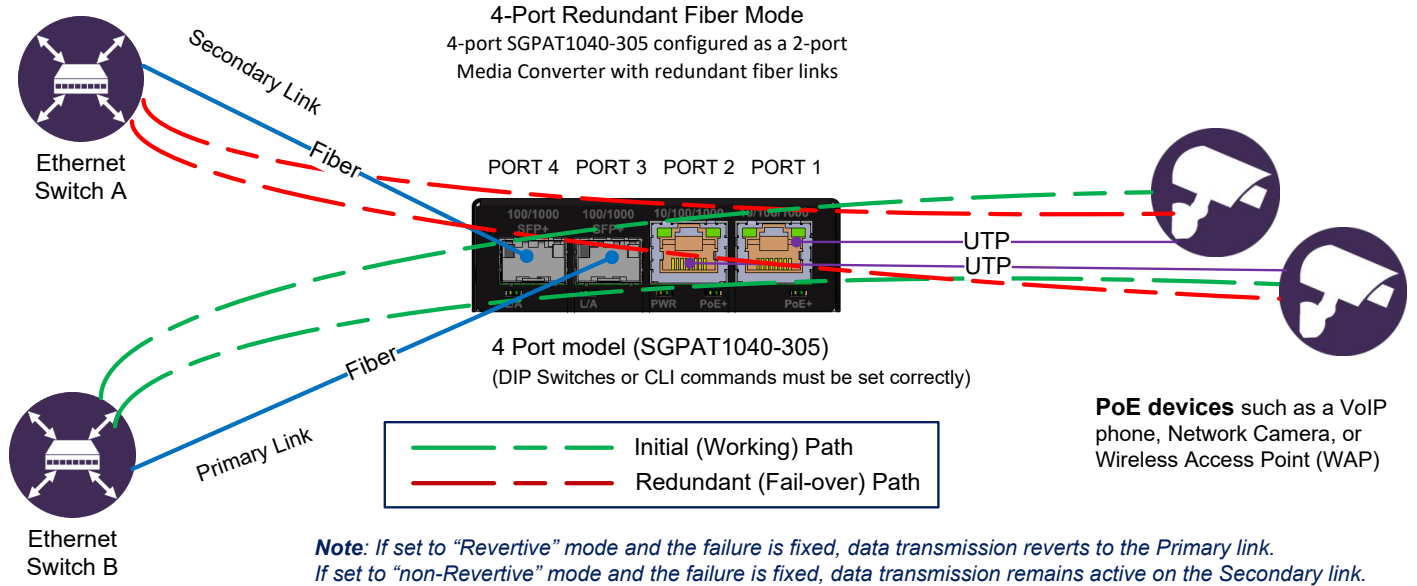

4-Port Redundant Fiber Mode Example

Note in the figure above: Port 3 is the Primary path and Port 4 is the Secondary path in terms of the fiber and data path lines shown.

Port Isolation: the SGPAT1040-305 supports Port Isolation. Port Isolation mode works differently on the SGPAT1040-205 than on the SGPAT1040-305 in terms of data flow ports/directions. **Note** the following:

- If Dual Converter mode is Enabled, Redundant mode is Unavailable.
 - If Redundant mode is Enabled, Dual Converter mode is Unavailable.
 - On the 3-port SGPAT1040-205 and the 4-port SGPAT1040-305, Port Isolation is a subset of Redundant mode.
- On the 3-port SGPAT1040-205, Port Isolation only takes affect when Redundant mode is Disabled.
On the 4-port SGPAT1040-305 Port Isolation only takes affect when Redundant mode is Enabled.
- On the 4-port SGPAT1040-305, Port Isolation is a sub-function of Redundant mode, and Redundant mode passes data between these ports:

Operating Mode	Dual Converter = Disabled Redundant = Enabled Port Isolation = Disabled			
Traffic Ingressing Port #	Can egress port #s: (green = yes, red = no, yellow = only when active)			
1	2	3	4	
2	1	3	4	
3	1	2	4	
4	1	2	3	

Operating Mode	Dual Converter = Disabled Redundant = Enabled Port Isolation = Enabled			
Traffic Ingressing Port #	Can egress port #s: (green = yes, red = no, yellow = only when active)			
1	2	3	4	
2	1	3	4	
3	1	2	4	
4	1	2	3	

4-Port Dual-Converter Mode

Dual Converter mode on the 4-port model (SGPAT1040-305) is like having two independent converters. In Dual Converter mode, SGPAT1040-305 Ports 4 and 2 make one converter, while Ports 3 and 1 make the other converter.

In Dual Converter Mode:

- Ports 1 and 3 can communicate with each other.
- Ports 2 and 4 can communicate with each other.
- Ports 1 and 3 are isolated from ports 2 and 4.

Port	Forwards Port Traffic to Port
4 (SFP)	2
3 (SFP)	1
2 (RJ45)	4
1 (RJ45)	3

The ports are labeled from left to right PORT 4,3,2,1 as shown below.

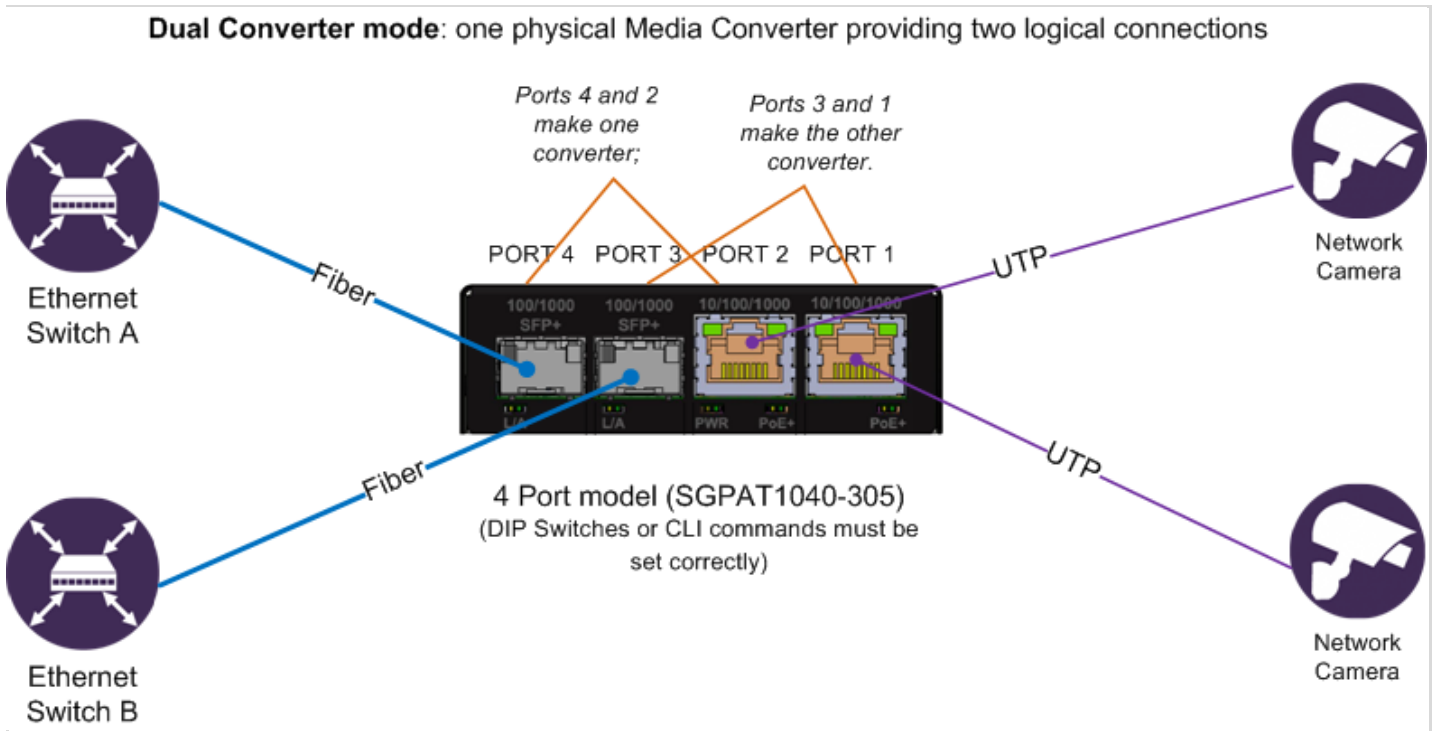

4-Port Dual-Converter Mode Example

4 CLI Commands

The SGPAT provides Command Line Interface (CLI) commands via the CONSOLE (RJ-45) port. Setting advanced features via the CLI requires CABLE-CCC-06 (Cisco DB9 to RJ-45 Console Cable, Blue, 6 ft.) connected to a PC running Terminal Emulation software (e.g., Tera Term or HyperTerminal). All of the features controlled via DIP switch can also be controlled via CLI commands. A CLI command consists of a letter or a letter followed by a number. The **c1** command is available to override DIP switch mode.

Connecting to the CONSOLE Port

Use a Cisco Blue cable to connect the SGPAT CONSOLE port (shown below) to the PC.

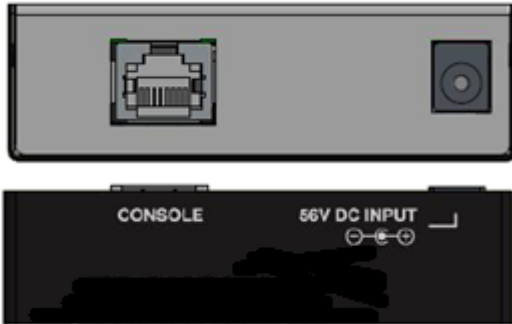

Terminal Emulator Settings

Baud Rate: 115200
 Data: 8-bit
 Parity: None
 Stop: 1-bit
 Flow Control: None

Command Summary

The SGPAT supports these CLI commands:

- a** – Active Link Pass Through {Disable: **a0** | Enable: **a1**} (see page 28)
- c** – CLI DIP Switch Override {Disable: **c0** | Enable: **c1**} (see page 29)
- d** – Dual Converter mode {Disable: **d0** | Enable: **d1**} (see page 30)
- e** – EEE Advertisement Mode {Port:1-2}{Disable: **e0** | Enable: **e1**} (see page 31)
- f** – Flow Control {PORT 1-4} {Disable: **f0** | Enable: **f1**} (see page 32)
- g** – Get PSE Status Report (see page 33)
- i** – Port Isolation Mode {Disable: **i0** | Enable: **i1**} (see page 34)
- l** – PSE Legacy PD Detect Mode {Port 1-2} {Disable:**l0** | Enable:**l1** } (see page 35)
- m** – Complete Status Report (see page 36)
- n** – Auto Negotiation {PORT 1-2} {Forced: **n0** | Enable: **n1**}{Forced Mode 1-4} (see page 37)
- p** – ALPT PD Power Reset {Port 1-2} {Disable: **p0** | Enable: **p1**} (see page 38)
- r** – Redundant Mode {Disable: **r 0** | Enable Revert: **r1** | Enable Non-Revert: **r2**} (see page 39)
- s** – SFP Port Mode {Port} {SGMII: **s0** | 100Base-FX/1000BaseX: **s1**} (see page 41)
- t** – Show Internal Temperature of Converter and SFP (see page 43)
- x** – Reset to Factory Defaults (see page 43)

To display all available SGPAT commands, press the **Enter** key twice.

```
Lantronix SGPAT Commands:
a - Active Link Pass Through {Disable:0 | Enable:1}
  example: a0 - ALPT Disable, a1 - ALPT Enable
c - CLI Dip Switch Override {Disable:0 | Enable:1}
  example: c0 - Dip Switch Control, c1 - CLI Control
d - Dual Converter Mode {Disable:0 | Enable:1}
  example: d0 - DC Disable, d1 - DC Enable
e - Energy Efficient Ethernet Adv. Ports {Port 1-2} {Disable:0 | Enable:1 }
  example: e10 - EEE Disable Port 1, e11 - EEE Enable Port 1
f - Flow Control {PORT 1-4} {Disable:0 | Enable:1}
  example: f10 - FC Port 1 Disable, f21 - FC Port2 Enable
g - Get PSE Status Report
I - Isolated Port Mode {Disable:0 | Enable:1}
  example: i0 - Isolation Disable, i1 - Isolation Enable
l - PSE Legacy Mode {Port 1-2} {Disable:0 | Enable:1 }
  example: l10-PSE Legacy Disable Port 1, l11-PSE Legacy Enable Port 1
m - Complete Status Report
n - Auto Negotiation(AN) {PORT 1-2}} {Forced:0 | Enable:1}{Forced Mode 1-4}:
  1- 100FULL, 2-100HALF, 3-10FULL, 4-10HALF
  example: n101 - AN Port 1 Forced to Speed:100M Duplex:Full,
  n21 - AN Port2 Enable
p - Auto Power PD RESET {Port 1-2} {Disable:0 | Enable:1}
  example: p10 - Auto Power PD RESET Disable Port 1,
  p11 - Auto Power PD RESET Enable Port 1
r - Redundancy Mode {Disable:0 | Enable Revert:1 | Enable Non-Revert:2}
  example: r0 - Disable, r1 - Enable Revert, r2 - Enable Non-Revert
s - SFP Port Mode{Port#:3 or 4}{SGMII:0 | 100/1000BaseX:1}
  format : s<port #><mode>
  example: s31, port# <3> mode 100/1000 <1>
t - Temperature of Switch
x - Factory Default

%
```

The SGPAT CLI commands are described in the following sections.

CLI Commands for Setting Advanced Features

Active Link Pass Through (ALPT) (a Command)

Note: this command is only accepted when CLI DIP Switch Override is enabled; otherwise the ALPT setting is controlled by DIP switch 3.

```
a - Active Link Pass Through {Disable: 0 | Enable: 1}
```

Type **a** and press the Enter key to display the current stored ALPT setting.

Type **a0** and press the Enter key to disable active link pass through.*

Type **a1** and press the Enter key to enable active link pass through.*

Model Descriptions

SGPAT1013-105: Once both the RJ-45 and the Fiber 1000Base-SX MM SC have established link, the ALPT function is engaged. Then if either link goes down, the link status will propagate to the other port.

SGPAT1039-105: Once both the RJ-45 and the Fiber 1000Base-SX MM LC have established link, then ALPT function is engaged. If either link goes down, the link status will propagate to the other port.

SGPAT1040-105: Once both the RJ-45 and the Fiber Dual Speed SFP port have established link. Then ALPT function is engaged. If either link goes down, the link status will propagate to the other port.

SGPAT1040-205: Only when the converter is in Redundancy Mode. Once link is established on the RJ-45 and one of the Open Dual Speed SFP ports, then the ALPT function is engaged. If the RJ45 or both the SFP ports goes down the link status will be propagated.

SGPAT1040-305: Only when the converter is in Dual Converter mode. ALPT will work independently for each virtual converter. Virtual converter 1 will use Ports 1 and 3, while Virtual converter 2 will use Ports 2 and 4. So for Virtual converter 1 ALP will not be engaged until a valid link up condition is detected for RJ-45 Port 1 and SFP Port 3. If either Port 1 or Port 3 goes down the link status will be propagated to the other port.

Virtual converter 2 ALP will not be engaged until a valid link up condition is detected for RJ-45 Port 2 and SFP Port 4. If either Port 2 or Port 4 goes down the link status will be propagated to the other port.

a Command Example:

```
a - Active Link Pass Through {Disable:0 | Enable:1}
      example: a0 - ALPT Disable, a1 - ALPT Enable
%a?
ALPT: Enabled

%a0

%a ?
ALPT: Disabled
%a1

%
```

CLI DIP Switch Override (c Command)

This command lets you view and enable or disable the current CLI DIP Switch mode setting.

The DIP switch default setting is valid until CLI DIP Switch Override is enabled (it is disabled by default).

```
c - CLI Dip Switch Override {Disable: 0 | Enable: 1}
```

Type **c** and press the Enter key to display the current stored CLI DIP switch override setting.

Type **c0** and press the Enter key to disable CLI DIP switch override.

Type **c1** and press the Enter key to enable CLI DIP switch override.

Operation is the same on all models.

The default is CLI DIP Switch mode Disabled.

c Command Example:

```
c - CLI Dip Switch Override {Disable:0 | Enable:1}
  example: c0 - Dip Switch Control, c1 - CLI Control
```

```
%c
DIP Switch Override: Disable
%c1
%c?
DIP Switch Override: Enable
%
```

Dual (2x) Converter Mode (d Command)

This command lets you view and enable or disable the current Dual Converter (DC) Mode setting.

Note: This CLI command is only accepted when CLI DIP Switch Override is enabled; otherwise the setting is controlled by DIP switch 6.

```
d - Dual Converter mode {Disable: 0 | Enable: 1}
```

Type **d** and press the Enter key to display the current stored Dual (2x) Converter Mode.

Type **d0** and press the Enter key to disable dual converter mode.*

Type **d1** and press the Enter key to enable dual converter mode.*

Model Descriptions

SGPAT1040-305: The **d1** command will separate the 4-port device into two virtual 2-Port Media Converters.

The two virtual media converters will operate independently of each other:

<u>Virtual Converter 1</u>	<u>Virtual Converter 2</u>
Port 1	Port 2
Port 3	Port4

d Command Example:

```
d - Dual Converter Mode {Disable:0 | Enable:1}
  example: d0 - DC Disable, d1 - DC Enable

%d0
Dual Converter Mode Stored

%d?
Dual Converter Mode: Disable

%d1
Dual Converter Mode Stored

%d?
Dual Converter Mode: Enabled 1 to 3 and 2 to 4 only

%
```

TP Energy Efficient Ethernet (EEE) Advertisement Mode (e Command)

This command lets you view and enable or disable EEE Advertisement Mode for all SGPAT ports.

```
e - EEE Advertisement Mode {Port:1-2}{Disable: 0 | Enable: 1}
```

Type **e** and press the Enter key on the keyboard to display the current stored TP EEE Advertisement Mode.

Type **e10** and press the Enter key to disable EEE Advertisement on Port 1.

Type **e11** and press the Enter key to enable EEE Advertisement on Port 1.

Type **e20** and press the Enter key to disable EEE Advertisement on Port 2.

Type **e21** and press the Enter key to enable EEE Advertisement on Port 1.

The default is EEE Advertisement Mode enabled for all ports.

Model Descriptions

SGPAT1013-105, SGPAT1039-105, SGPAT1040-105, SGPAT1040-205: Only Copper Port 1 of these models supports EEE. When EEE is enabled the port will Advertise and Support IEEE 802.3az Energy Efficient Ethernet. This function is auto negotiated through Clause 45. When both link partners support EEE the device will save a minimum of 0.25W of power per port. When EEE is disabled the port will not be able to enter the lower power mode.

SGPAT1040-305: Both Copper Ports 1 and 2 of this model will support EEE. When EEE is enabled the port will advertise and support IEEE 802.3az Energy Efficient Ethernet. This function is auto negotiated through Clause 45. When both link partners support EEE the device will save a minimum of 0.25W of power per port. When EEE is disabled the port cannot enter the lower power mode.

e Command Example:

```
%e?  
EEE: Port 1 Enable  
EEE: Port 2 Enable  
  
%e10  
%e?  
EEE: Port 1 Disable  
EEE: Port 2 Enable  
%
```

Flow Control (f Command)

This command lets you view and enable or disable SGPAT Flow Control for the port specified in the command.

```
f - Flow Control {PORT 1-4} {Disable: 0 | Enable: 1}
```

Type **f** and press the Enter key on the keyboard to display the current stored flow control setting.

Type **f10** and press the Enter key to disable flow control on port 1.

Type **f11** and press the Enter key to enable flow control on port 1.

Type **f20** and press the Enter key to disable flow control on port 2.

Type **f21** and press the Enter key to enable flow control on port 2.

Type **f30** and press the Enter key to disable flow control on port 3.

Type **f31** and press the Enter key to enable flow control on port 3.

Type **f40** and press the Enter key to disable flow control on port 4.

Type **f41** and press the Enter key to enable flow control on port 4.

Operation is the same on all models.

f Command Example:

```
f - Flow Control {PORT 1-4} {Disable:0 | Enable:1}
      example: f10 - FC Port 1 Disable, f21 - FC Port2 Enable
%f
Flow Control Status
Port 1:Enabled
Port 2:Enabled
Port 3:Disabled
Port 4:Disabled

%f?
Flow Control Status
      Port 1:Disabled
      Port 2:Disabled
      Port 3:Disabled
      Port 4:Disabled

%f11
Flow Control Mode Stored

%
```

Get PSE Status Report (g Command)

This command displays current SGPAT status.

g – Get PSE Status Report

Type **g** and press the Enter key to show the PD detection, classification, voltage, current and power.

Model Descriptions

SGPAT1013-105, SGPAT1039-105, SGPAT1040-105, SGPAT1040-205: Only Copper Port 1 of these models will display the status of the PD as seen by the PSE controller.

SGPAT1040-305: Both Copper Port 1 and 2 of this model will display the status of the PD as seen by the PSE controller.

g Command Example:

```
%g
PSE Port 1:
  Class State:      Unknown
  Detect State:     Short
  Current Reading:  0.000
  Voltage Reading:  0.000
  Wattage Reading:  0.000
PSE Port 2:
  Class State:      Unknown
  Detect State:     Short
  Current Reading:  0.000
  Voltage Reading:  0.000
  Wattage Reading:  0.000
%
```

Port Isolation Mode (I Command)

This command lets you view and configure the current Isolation Port mode.

```
I - Isolated Port Mode {Disable: 0 | Enable: 1}
```

Type **I** and press the Enter key to display the current stored Port Isolation mode.

Type **i0** and press the Enter key to disable port isolation.

Type **i1** and press the Enter key to enable port isolation.

Model Descriptions

SGPAT1040-205: Only when this converter model is in Normal Mode, the two SFP ports will be isolated and will only be able to communicate to the TP port. The TP port will be able to communicate to both SFP ports.

SGPAT1040-305: Only when this converter model is in Redundancy mode, the two TP ports will only be able to communicate to the active SFP port. The active SFP port will be able to communicate to both TP ports.

I Command Example:

```
I - Isolated Port Mode {Disable:0 | Enable:1}
  example: i0 - Isolation Disable, i1 - Isolation Enable

%i1
%i
  Port Isolation: Unavailable

%i
  Port Isolation: Unavailable
```

PSE Port Legacy Detect Mode (I Command)

This command displays the current stored PSE Port Legacy Detect Mode (enabled or disabled).

```
I - PSE Legacy Mode {Port 1-2} {Disable:0 | Enable:1 }
```

Type **I** and press the Enter key to display the current stored PSE Port Legacy Detect Mode.

Type **I10** and press the Enter key to disable legacy detection mode and use standard IEEE detection on Port 1.

Type **I11** and press the Enter key to enable legacy detection mode only on Port 1.

Type **I20** and press the Enter key to disable legacy detection mode and use standard IEEE detection on Port 2.

Type **I21** and press the Enter key to enable legacy detection mode only on Port 2.

Model Descriptions

SGPAT1013-105, SGPAT1039-105, SGPAT1040-105, SGPAT1040-205: Copper Port 1 of these models will enable and disable the support for legacy type PD devices.

SGPAT1040-305 : Both Copper Ports 1 and 2 of this model will enable and disable the support for legacy type PD devices.

I Command Example:

```
%I ?
PSE Legacy: Port 1 Disabled(IEEE 802.3 at/af Devices Detected)
PSE Legacy: Port 2 Disabled(IEEE 802.3 at/af Devices Detected)

%I11
PSE Legacy Mode Stored

%I?
PSE Legacy: Port 1 Enable(Only Legacy Devices Detected)
PSE Legacy: Port 2 Disabled(IEEE 802.3 at/af Devices Detected)

%
```

Complete Configuration Status Report (m Command)

This command displays the current SGPAT configuration settings.

m – Complete Status Report

Type m and press the Enter key to display the current converter configuration settings. (This works the same as pressing a, c, d, e, f, l, l, n, p, r, s).

Operation is the same on all models.

m Command Example:

```
%m?  
ALPT: Unavailable  
DIP Switch Override: Enable  
Dual Converter Mode: Disable  
Flow Control Status  
    Port 1:Disabled  
    Port 2:Disabled  
    Port 3:Disabled  
    Port 4:Disabled  
Port Isolation: Unavailable  
PSE Legacy: Port 1 Disabled(IEEE 802.3 at/af Devices Detected)  
PSE Legacy: Port 2 Disabled(IEEE 802.3 at/af Devices Detected)  
Auto Negotiation: Port 1 Enable  
Auto Negotiation: Port 2 Enable  
Auto Power PD Reset: Unavailable  
Redundant Mode: Disabled  
SFP Port 3:100/1000  
SFP Port 4:100/1000  
  
%
```

Auto Negotiation (AN) enable for TP ports or AN disable with port forced mode (n Command)

This command lets you view and configure SGPAT Auto Negotiation, Speed, and Duplex settings.

```
n - Auto Negotiation (AN) {PORT 1-2} {Forced: 0 | Enable: 1} {Forced Mode 1-4}
```

Type **n** and press the Enter key to display the current stored Auto Negotiation setting.

Type **n11** and press the Enter key to enable Auto Negotiation on TP port 1.

Type **n21** and press the Enter key to enable Auto Negotiation on TP port 2 (only when TP port 2 is present).

Type **n101** and press the Enter key to disable Auto Negotiation and force TP port 1 to 100Base full duplex mode.

Type **n102** and press the Enter key to disable Auto Negotiation and force TP port 1 to 100Base half-duplex mode.

Type **n103** and press the Enter key to disable auto negotiation and force TP port 1 to 10Base full duplex mode.

Type **n104** and press the Enter key to disable Auto Negotiation and force TP port 1 to 10Base half-duplex mode.

Type **n201** and press the Enter key to disable Auto Negotiation and force TP port 2 to 100Base full duplex mode (only when TP port 2 is present).

Type **n202** and press the Enter key to disable Auto Negotiation and force TP port 2 to 100Base half-duplex mode (only when TP port 2 is present).

Type **n203** and press the Enter key to disable Auto Negotiation and force TP port 2 to 10Base full duplex mode (only when TP port 2 is present).

Type **n204** and press the Enter key to disable Auto Negotiation and force TP port 2 to 10Base half-duplex mode (only when TP port 2 is present).

Operation is the same on all models.

n Command Example:

```
%n - Auto Negotiation(AN) {PORT 1-2} {Forced:0 | Enable:1}{Forced Mode 1-4}:
    1- 100FULL, 2-100HALF, 3-10FULL, 4-10HALF
    example: n101 - AN Port 1 Forced to Speed:100M Duplex:Full,
             n21 - AN Port2 Enable
%n
Auto Negotiation: Port 1 Enable
Auto Negotiation: Port 2 Enable

%n - Auto Negotiation(AN) {PORT 1-2} {Forced:0 | Enable:1}{Forced Mode 1-4}:
    1- 100FULL, 2-100HALF, 3-10FULL, 4-10HALF
    example: n101 - AN Port 1 Forced to Speed:100M Duplex:Full,
             n21 - AN Port2 Enable
%
```

ALPT PD Power Reset (p Command)

This command will cycle power to the PD device when ALPT is enabled, and the link is lost on the SFP or fixed optic port. The converter then sets a 2-3 minute time out period internally. During the time out period the converter will not initiate another power cycle of the PD power reset if the fiber link status is changing. After the internal timer has expired and the fiber link is established the power cycle event will then be re-armed.

```
p - ALPT PD Power Reset {Port 1-2} {Disable: 0 | Enable:1}
```

Type **p** and press the Enter key to display the current stored ALPT PD power reset setting.

Type **p10** and press the Enter key to disable ALPT PD power reset on TP port 1.

Type **p20** and press the Enter key to disable ALPT PD power reset on TP port 2 (only when TP port 2 is present).

Type **p11** and press the Enter key to enable ALPT PD power reset on TP port 1.

Type **p21** and press the Enter key to enable ALPT PD power reset on TP port 2 (only when TP port 2 is present).

Operation is the same on all models.

p Command Example:

```
%p - ALPT PD RESET {Port 1-2} {Disable:0 | Enable:1}
      example: p10 - ALPT PD RESET Disable Port 1,
              p11 - ALPT PD RESET Enable Port 1
%p
ALPT PD Reset: Port 1 Enabled
ALPT PD Reset: Port 2 Enabled

%p
Auto Power PD Reset: Unavailable

%
```

SFP Port Redundancy Mode (r Command)

Note: This command is only accepted when CLI DIP Switch Override is enabled; otherwise, the setting is controlled by DIP switches 4 and 5.

```
r - Redundancy Mode {Disable: 0 | Enable Revert: 1 | Enable Non-Revert: 2}
```

Type **r** and press the Enter key to display the current stored Redundancy Mode.

Model Descriptions

SGPAT1040-205: Type **r0** and press the Enter key to disable Redundancy mode and put the switch in Normal mode.* (DIP Switch 4 up.)

Type **r1** and press the Enter key to set the converter to Redundant Revertive mode. Port 2 is the primary port and port 3 will be the secondary port. Traffic through the converter will be sent through the primary port. If the link goes down on the primary port the converter will switch the traffic to the secondary port. If the link on the primary port is reestablished the converter will move the traffic back to the primary port. *(DIP Switch 4 Down and 5 Up)

Type **r2** and press the Enter key to set the converter to Redundant Non-revertive mode. Port 2 is the primary port and port 3 will be the secondary port. Traffic through the converter will be sent through the primary port. If the link goes down on the primary port the converter will switch the traffic to the secondary port. If the link on the primary port is reestablished the converter will not move the traffic back to the primary port unless the secondary link goes down. * (DIP Switch 4 Down and 5 Down.)

SGPAT1040-305: Type **r0** and press the Enter key to disable Redundant mode and put the switch in Normal mode.* (DIP Switch 4 Up.)

Type **r1** and press the Enter key to set the converter to Redundant Revertive mode. Port 3 is the primary port and port 4 will be the secondary port. Traffic through the converter will be sent through the primary port. If the link goes down on the primary port, the converter will switch the traffic to the secondary port. If the link on the primary port is re-established, the converter will move the traffic back to the primary port. * (DIP Switch 4 Down and 5 Up.)

Type **r2** and press the Enter key to set the converter to Redundant Non-revertive mode. Port 3 is the primary port and port 4 will be the secondary port. Traffic through the converter will be sent through the primary port. If the link goes down on the primary port, the converter will switch the traffic to the secondary port. If the link on the primary port is re-established, the converter will not move the traffic back to the primary port unless the secondary link goes down. * (DIP Switch 4 Down and 5 Down.)

r Command Example:

```
%r - Redundancy Mode {Disable:0 | Enable Revert:1 | Enable Non-Revert:2}
      example: r0 - Disable, r1 - Enable Revert, r2 - Enable Non-Revert
%r
Redundant Mode: Unavailable

%r1
%r
Redundant Mode: Unavailable

%r?
Redundant Mode: Unavailable

%r ?
Redundant Mode: Unavailable

%r0
Redundant Mode Stored
```

```
%r?  
Redundant Mode: Unavailable
```

```
%r1  
Redundant Mode Stored
```

```
%r  
Redundant Mode: Unavailable
```

```
%r2  
Redundant Mode Stored
```

```
%r  
Redundant Mode: Unavailable
```

```
%
```

SFP Port Mode (s Command)

Note: This CLI command is only accepted when CLI DIP Switch override is enabled; otherwise the setting is controlled by DIP switch 1 or 2.

```
s - SFP Port Mode {Port} {SGMII: 0 | 100Base-FX/1000BaseX: 1}
```

Type **s** and press the Enter key to display the current stored SFP port mode.

Model Descriptions

SGPAT1040-105: Type **s20** and press the Enter key to set port 2 to SGMII mode.* (DIP Switch 1.)

Type **s21** and press the Enter key to set port 2 to Auto detect 100Base-FX or 1000BaseX MSA-compliant SFP modules.* (DIP Switch 1.)

SGPAT1040-205: Type **s20** and press the Enter key to set port 2 to SGMII mode.* (DIP Switch 1.)

Type **s21** and press the Enter key to set port 2 to Auto detect 100Base-FX or 1000BaseX MSA compliant SFP modules.* (DIP Switch 1.)

Type **s30** and press the Enter key to set port 3 to SGMII mode.* (DIP Switch 2.)

Type **s31** and press the Enter key to set port 3 to Auto detect 100Base-FX or 1000BaseX MSA compliant SFP modules.* (DIP Switch 2.)

SGPAT1040-305: Type **s30** and press the Enter key to set port 3 to SGMII mode.*(DIP Switch 1.)

Type **s31** and press the Enter key to set port 3 to Auto detect 100Base-FX or 1000BaseX MSA compliant SFP modules.* (DIP Switch 1)

Type **s40** and press the Enter key to set port 4 to SGMII mode.* (DIP Switch 2.)

Type **s41** and press the Enter key to set port 4 to Auto detect 100Base-FX or 1000BaseX MSA compliant SFP modules.* (DIP Switch 2.)

s Command Example:

```
s - SFP Port Mode{Port#:3 or 4}{SGMII:0 | 100/1000BaseX:1}
  format : s<port #><mode>
  example: s30, port# <3> mode 100/1000 <1>

%s
SFP Port 3:100/1000
SFP Port 4:100/1000

%s?
SFP Port 3:100/1000
SFP Port 4:100/1000

%s32

%s
SFP Port 3:100/1000
SFP Port 4:100/1000

%s30
```

```
SFP Mode Stored
```

```
%s
```

```
SFP Port 3:SGMII
```

```
SFP Port 4:100/1000
```

```
%
```

Temperature of Converter (t Command)

This command displays SGPAT and SFP temperature information in Degrees Celsius.

```
t -Internal Temperature of Converter and SFP
```

Type **t** and press the Enter key to display the current temperature of the SGPAT and SFP devices (if available).

Operation is the same on all models.

t Command Example:

```
t - Temperature of Switch

%t
Temperature SW      = 31 Degrees C
NO DMI Port 3
Temperature Port 4 = 45 Degrees C
%
```

Reset to Factory Defaults (x Command)

This command returns the SGPAT to the original factory default settings.

```
x -Factory Defaults
```

Type **v** and press the Enter key to reset the SGPAT to its factory default settings. Operation is the same on all models.

x Command Example:

```
%x
CLI Factory Defaults Stored

%x ?
CLI Factory Defaults Stored

%
```

Messages

Message: *PSE 0 Timer Disable*

Meaning: The converter has set a 2-3 minute time out period internally.

Recovery: See the [Active Link Pass Through \(ALPT\) \(a Command\)](#) on page 28.

5 Troubleshooting

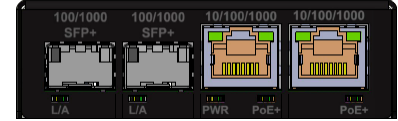

1. Is the PWR (*power*) LED lit?

NO

- Is the power adapter the proper type of voltage and cycle frequency for the AC outlet?
- Is the power adapter properly installed in the SGPAT and in the outlet?
- If power LED blinking, may indicate incorrect or faulty power supply.

YES

- Proceed to step 2.

2. Verify config settings. The RJ45 port may auto-negotiate speed and duplex with the link partner if enabled, otherwise it is defined by the DIP switch or CLI command. Some config settings are DIP switch defined only. See [6-Position DIP Switch](#) on page 12 or see [4. CLI Commands](#) on page 26.

3. Is the L/A LED lit Amber or green?

NO

- Check the copper cables for proper connection. Check the [Auto-Negotiation](#) setting.

YES – Amber

- The SGPAT has selected half-duplex mode. If this is not the correct mode, disconnect and reconnect the copper cable to restart the negotiation process. See [Status LEDs](#) on page 14.
- Proceed to step 4.

YES – Green

- The SGPAT has selected full-duplex mode. If this is not the correct mode, disconnect and reconnect the copper cable to restart the negotiation process.
- Proceed to step 4.

4. Is the 100/1000 SFP LED lit?

NO

- Check the fiber cables for proper connection. See [Status LEDs](#) on page 14.
- Verify that the TX and RX cables on the SGPAT are connected to the RX and TX ports, respectively, on the other device.

YES

- Proceed to step 5.

5. Is the 10/100/1000 LED lit?

NO

- The SGPAT is in 10 Mb/s mode. If this is not the correct speed, disconnect and reconnect the copper cable to restart the negotiation process. See [Status LEDs](#) on page 14.

YES – Flashing Amber

- The SGPAT is in 100 Mb/s mode. If not the correct speed, disconnect and reconnect the copper cable to re- negotiate. Check the [Auto-Negotiation](#) setting.
- Contact Tech Support.

YES – Flashing Green

- The SGPAT is in 1000 Mb/s mode. If this is not the correct speed, disconnect and reconnect the copper cable to re- negotiate. Check the [Auto-Negotiation](#) setting.

6. Check the PoE+ LED condition. See [PSE Status LED Error Indicators](#) on page 14.

7. Record Information (below) and then contact Tech Support.

Record System and Device Information

After performing the troubleshooting procedures above, and before calling or emailing Tech Support, record as much information as possible to help the Tech Support Specialist. The Serial Number and MAC Address are printed on the bottom of each SGPAT. The HW Version and the FW Version are displayed on the device label and via CLI command.

1. Record SGPAT information:

Serial Number: _____ MAC Address: _____

HW Version: _____ FW Version: _____

2. Record PWR LED Status: _____

3. Record TP LED Status: _____

4. Record Fiber LED Status: _____

5. Record POE+ LED Status: _____

6. List any error messages and attempted recovery actions: _____

7. Your Lantronix service contract number: _____

8. Describe the problem: _____

9. Describe action(s) already taken to resolve the problem (e.g., change mode, reset, etc.): _____

10. The model # and serial # of other Lantronix products in the network: _____

11. Describe your network environment (layout, cable type, cable distance, etc.): _____

12. This device history (i.e., have you returned the device before, is this a recurring problem, previous Return Material Authorization (RMA) numbers, etc.): _____

13. List 3rd party equipment in the network (e.g., Ethernet switch, Remote camera, etc.): _____

6 Power Supply Features and Specifications

The 25155 and 25188 Power Supplies are external (desktop) power adapters with a 2-Pin barrel connector. **Warning:** You must either use the provided external AC-DC adapter or you must ensure that the alternate power source meets the IEEE 802.3at isolation requirements. Power supply features include:

- Universal AC input/ Full Range
- Energy Efficiency Level VI
- ErP Step 2 Compliant
- NRCan and GEMS Compliant
- Output Protections: OVP/SCP/OC
- No Load Power Consumption <0.21W



Power Supply Specifications

Output Characteristics

DC Output	56V; Sufficient to support two RJ-45 PoE+ Powered Devices (PDs)
Rated Current	1.17A
Ripple and Noise	±2% Vo @ Rated Load
Load Regulation (Typ.)	±5%
Transient Response (Typ.)	0.5mS for 50% Load Change
Hold-up Time (Typ.)	10mS @ Rated Load
Output Protection	Short Circuit, Over Voltage, Over Current protection

Input Characteristics

Voltage Range	100VAC~240VAC
Frequency Range	50Hz-60Hz
Efficiency	DoE Level VI, Energy Star, ErP Step 2, NRCan & GEMS Level VI Certified
AC Current (max)	1.4A
Input Protection	Internal Primary Current Fuse, Inrush Limiting
Leakage Current	0.25mA (2 Conductor), 3.5mA (3 Conductor)

Environmental Characteristics

Operating Temperature	0°C~40°C
Operating Relative Humidity	20% RH to 80% RH
Storage Temperature	-20°C~80°C, 10% RH to 90% RH
Topology	Switching Flyback
Dielectric Withstand	3000VAC Primary-Secondary
EMI Conduction & Radiation	Compliance to EN55022 Class B
Harmonic Current	Compliance to EN61000-3-2, 3
EMS Immunity	IEC61000-4-2, 3, 4, 5, 6, 8, 11

Other Characteristics

MTBF	300,000Hrs (25°C, Telcordia SR-332)
Dimensions (LxWxH)	115 x 53 x 38 mm (4.52 x 2.08 x 1.49 inches)
Weight	310g (0.68 lbs.)



Power Supply Dimensions

The Power Supply dimensions are given below (in mm).

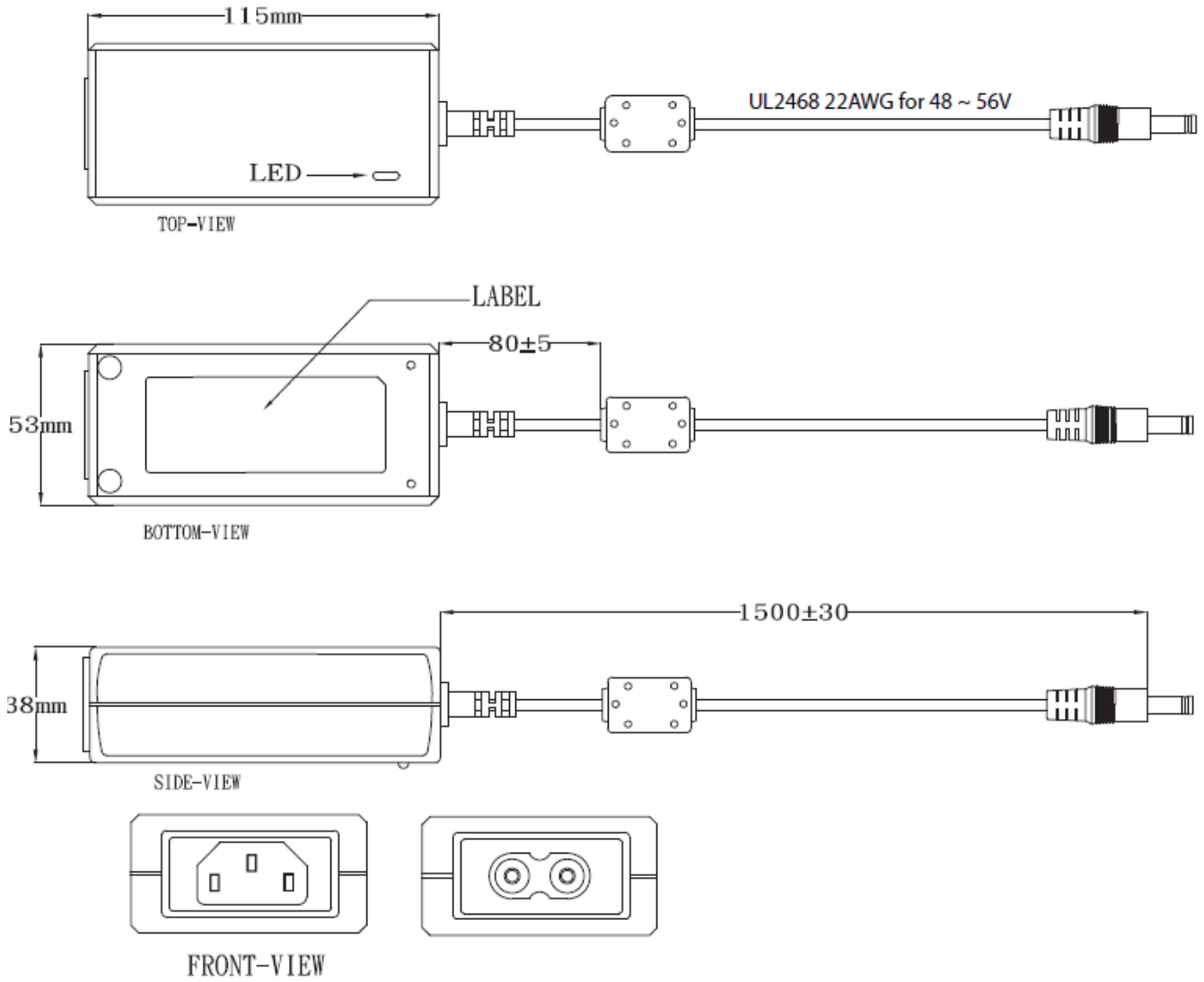

7 Compliance Information

Declaration of Conformity

Manufacturer's Name: Lantronix, Inc.

Manufacturer's Address: 48 Discovery, Suite 250, Irvine, California 92618 USA

Declares that the product(s): SGPAT1013-105, SGPAT1039-105, SGPAT1040-105, SGPAT1040-205, SGPAT1040-305

Conforms to the following Product Regulations:

FCC Part 15 Class A, EN 55032:2012, EN 55024:2010

Directive 2014/30/EU

Low-Voltage Directive 2014/35/EU

IEC/EN 60950-1:2006+A2:2013

2011/65/EU EN 50581:2012

With the technical construction on file at the above address, this product carries the CE Mark

I, the undersigned, hereby declare that the equipment specified above conforms to the above Directive(s) and Standard(s).

Place: Irvine, California

Date: April 27, 2022

Signature: *Eric Bass*

Full Name: Eric Bass

Position: Vice President of Engineering

CE Mark

FCC regulations

This equipment has been tested and found to comply with the limits for a Class A digital device, pursuant to Part 15 of the FCC rules. These limits are designed to provide reasonable protection against harmful interference when the equipment is operated in a commercial environment. This equipment generates, uses and can radiate radio frequency energy and, if not installed and used in accordance with the instruction manual, may cause harmful interference to radio communications.

Operation of this equipment in a residential area is likely to cause harmful interference, in which case the user will be required to correct the interference at the user's own expense.

Canadian regulations

This digital apparatus does not exceed the Class A limits for radio noise for digital apparatus set out on the radio interference regulations of the Canadian Department of Communications.

Le interfe appareil numérique n'émet pas de bruits radioélectriques dépassant les limites applicables aux appareils numériques de la Class A prescrites dans le Règlement sur le brouillage radioélectrique édicté par le ministère des Communications du Canada.

European regulations

Warning This is a Class A product. In a domestic environment this product may cause radio interference in which case the user may be required to take adequate measures.

Achtung !

Dieses ist ein Gerät der Funkstörgrenzwertklasse A. In Wohnbereichen können bei Betrieb dieses Gerätes Rundfunkstörungen auftreten. In diesem Fall ist der Benutzer für Gegenmaßnahmen verantwortlich.

Attention !

Ceci est un produit de Classe A. Dans un environnement domestique, ce produit 49nterf de créer des 49nterferences radioélectriques, il appartiendra alors à l'utilisateur de prendre les mesures spécifiques appropriées.



In accordance with European Union Directive 2002/96/EC of the European Parliament and of the Council of 27 January 2003, Lantronix will accept post usage returns of this product for proper disposal. The contact information for this activity can be found in the 'Contact Us' portion of this document.



CAUTION: RJ connectors are NOT INTENDED FOR CONNECTION TO THE PUBLIC TELEPHONE NETWORK. Failure to observe this caution could result in damage to the public telephone network.

Der Anschluss dieses Gerätes an ein öffentliches Telekommunikationsnetz in den EGMitgliedstaaten verstösst gegen die jeweiligen einzelstaatlichen Gesetze zur Anwendung der Richtlinie 91/263/EWG zur Angleichung der Rechtsvorschriften der Mitgliedstaaten über Telekommunikationsendeinrichtungen einschliesslich der gegenseitigen Anerkennung ihrer Konformität.

Trade Agreement Act (TAA) Compliant Products

See <https://www.lantronix.com/legal/rohs/taa-compliant-products/>

NDAA, RoHS, REACH and WEEE Compliance

See <https://www.lantronix.com/legal/rohs/>

**Lantronix Corporate Headquarters**

48 Discovery, Suite 250

Irvine, CA 92618, USA

Toll Free: 800-526-8766

Phone: 949-453-3990

Fax: 949-453-3995

Technical Support

Online: <https://www.lantronix.com/technical-support/>

Sales Offices

For a current list of our domestic and international sales offices, go to the Lantronix web site at www.lantronix.com/about/contact.