



M/GE-ISW-xx-01
Hardened Mini Gigabit Stand-Alone Media Converters
User Guide

Part Number 33627
Revision F October 2023

Intellectual Property

© 2021-2023 Lantronix, Inc. All rights reserved. No part of the contents of this publication may be transmitted or reproduced in any form or by any means without the written permission of Lantronix. *Lantronix* is a registered trademark of Lantronix, Inc. in the United States and other countries. All other trademarks and trade names are the property of their respective holders. Patented: [patents.lantronix.com](https://www.lantronix.com/patents); additional patents pending.

Warranty

For details on the Lantronix warranty policy, go to <http://www.lantronix.com/support/warranty>.

Contacts

Lantronix Corporate Headquarters

48 Discovery, Suite 250
Irvine, CA 92618, USA
Toll Free: 800-526-8766
Phone: 949-453-3990
Fax: 949-453-3995

Technical Support

Online: <https://www.lantronix.com/technical-support/>

Sales Offices

For a current list of our domestic and international sales offices, go to www.lantronix.com/about/contact.

Disclaimer

All information contained herein is provided "AS IS." Lantronix undertakes no obligation to update the information in this publication. Lantronix does not make, and specifically disclaims, all warranties of any kind (express, implied or otherwise) regarding title, non-infringement, fitness, quality, accuracy, completeness, usefulness, suitability or performance of the information provided herein. Lantronix shall have no liability whatsoever to any user for any damages, losses and causes of action (whether in contract or in tort or otherwise) in connection with the user's access or usage of any of the information or content contained herein. The information and specifications contained in this document are subject to change without notice.

Revision History

Date	Rev.	Comments
9/18/15	A	Initial release
12/30/15	B	Add M/GE-ISW-LC-01, M/GE-ISW-SX-01, and M/GE-ISW-LX-01 information.
2/2/16	C	Update weight and operating temp specs.
2/15/23	D	Initial Lantronix re-brand. Update DoC and artwork.
10/5/23	E	Add optional accessories and update specifications and CE DoC.
10/23/23	F	Update CE DoC.

Table of Contents

Product Description	4
Ordering Information	4
Optional Accessories (sold separately)	4
Features	4
Application Example.....	5
Package Contents	5
Installation	6
Electrostatic Discharge (ESD)	6
Installation Options	6
Copper and Fiber Ports	8
Connect Fiber Cables	9
Connect the Twisted-Pair Copper Cable	9
Connecting Power	10
Operation	11
Status LEDs	11
Fiber Port Mode at Power Up	11
Product Features	12
Cable and Optic Specifications	15
Troubleshooting Cat 6 & Cat 6A Structured Copper Cabling Systems	18
Technical Specifications.....	18
Troubleshooting	19
Compliance Information	20
CE Declaration of Conformity	20
FCC regulations	20
Canadian regulations	20
European regulations.....	21

Product Description

The M/GE-ISW Series is a hardened Gigabit Ethernet Mini media converter that provides cost effective media conversion between 10/100/1000Base-T ports and 1000Base-SX/LX ports for hardened or outdoor environments. With its supported operating temperature range of -40°C to +75°C, the Mini offers a space saving alternative for converting copper to fiber in extreme environments.

Ordering Information

Model	Description
M/GE-ISW-SX-01	Hardened Mini 10/100/1000Base-T to 1000Base-SR converter, SC, MM
M/GE-ISW-LX-01	Hardened Mini 10/100/1000Base-T to 1000Base-LX converter, SC, SM, 10km
M/GE-ISW-SFP-01	Hardened Mini 10/100/1000Base-T to 100/1000Base-X converter, open SFP slot
M/GE-ISW-LC-01	Hardened Mini 10/100/1000Base-T(RJ-45) to 1000Base-SX, LC, MM

Optional Accessories (sold separately)

Model	Description
SFP Modules	Lantronix SFP transceiver modules are the ideal solution for any network supporting a large variety of data rates and fiber types. Order separately.
SPS-UA12DHT	Power Supply; 12 VDC, 18W, External AC/DC Desktop. Order separately.
25165	Power Supply; Universal AC/DC Input DIN Rail Mountable +12 VDC. Order separately.
WMBM	Wall Mount Bracket Mini. Order separately.
RMBM	Rack Mount Bracket for Mini Media Converters in the RMS19-SA4-02. Order separately.

Features

- One 10/100/1000BASE-T RJ-45 port
- One 100/1000BASE-X dual speed SFP slot, or a fixed 1000BASE-SX port
- Fixed configuration, no DIP switches
- Industrial grade
- Powered by 12VDC-48VDC or 24VAC-36VAC external power supply
- Auto-Negotiation, Link Pass Through, and Active Link Pass Through
- Auto-MDI/MDIX on copper port
- NDAA Compliant and TAA Compliant
- Unit and Port LEDs allow for quick status information
- Fixed Full-Duplex on Fiber
- Jumbo Frame (up to 10240Bytes)
- Supports DC & AC Input Power via terminal block; includes barrel connector pig-tail cable
- Mounting options: DIN Rail clip and Velcro included; Wall mount bracket sold separately
- Overload Current Protection
- Reverse Polarity Protection

Application Example

The M/GE-ISW-xx-01 is used to convert 100/1000BASE-X fiber port to 10/100/1000BASE-T copper port, or vice versa. It can be used trouble-free in outdoor or other challenging applications.

The illustration below shows the M/GE-ISW-xx-01 in an example configuration, with a security camera.

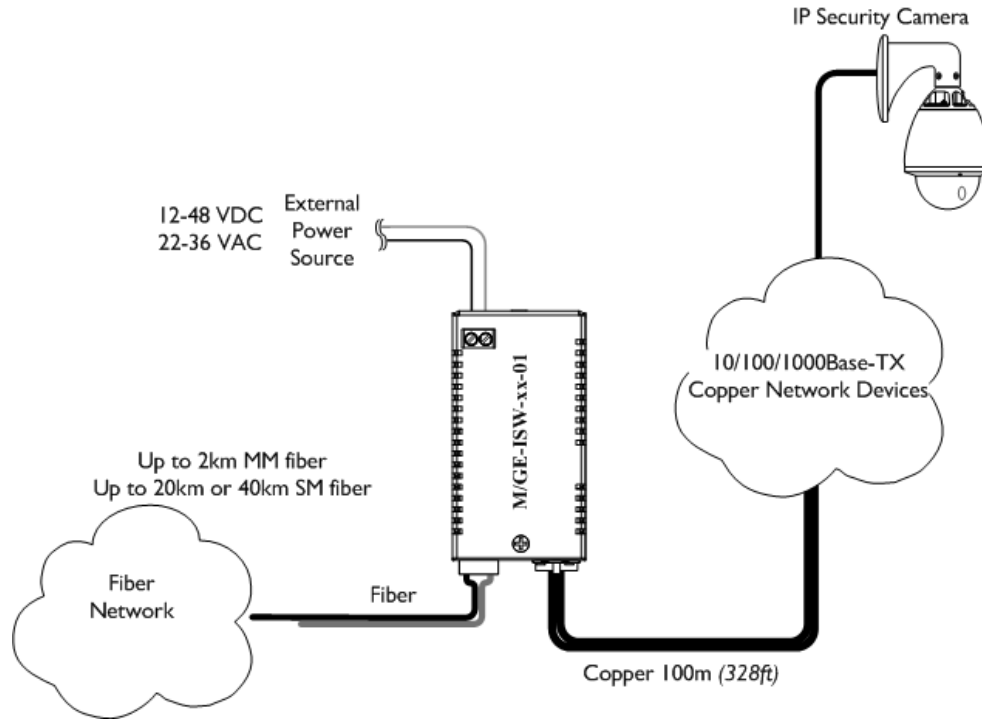

Package Contents

Check that your package contains the following items. Contact your point of purchase if anything is missing or damaged. Save the packing materials for possible future use.

- M/GE-ISW-xx-01 Hardened Mini Ethernet Converter with Euro Block power connection
- Pig-tail Cable with Barrel Connector
- Industrial Velcro Mounting Strip
- DIN Rail Mounting Brackets
- Documentation Postcard

Installation

Electrostatic Discharge (ESD)

Always observe the following ESD precautions when installing or handling the M/GE-ISW-xx-01 media converter:

- Do not remove the converter from its protective packaging until you are ready to install M/GE-ISW-xx-01 media converter.
- Wear an ESD wrist grounding strap before handling the M/GE-ISW-xx-01 media converter or its component. If you do not have a wrist strap, maintain grounded contact with the unit throughout any procedure requiring ESD protection.

Installation Options

You can install your media converter using the Industrial Velcro Mounting or the DIN Rail Mounting kit as described in the following sections. It can also be mounted in the M-MCR-01 Mini Chassis; see the related manual for details.

Installing Industrial Velcro

The industrial Velcro strip features a molded plastic hook and a heavy-duty, water-resistant adhesive for superior holding power on smooth surfaces, including plastic. It is designed for indoor and outdoor use.

To install the Industrial Velcro onto the media converter:

1. Clean and dry surface before application.
2. Peel tape from fastener and press firmly into place.
3. Adhesive reaches maximum strength after 24 hours.

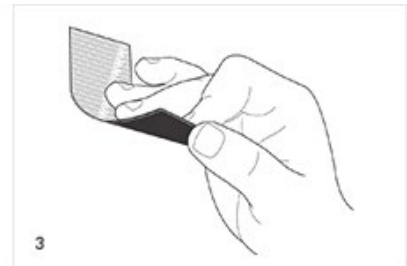

Note: Recommended for temperatures between 0°F to 150°F. Not recommended for fabrics, dashboards, flexible vinyl or underwater use. Continued exposure to full sunlight can damage fastener.

May not adhere well to certain types of brick; testing is recommended.

The VELCRO® Brand. © 2015 Velcro Industries B.V.

Installing DIN Rail Clip

A DIN Rail Clip and a 4-40 Screw are included.

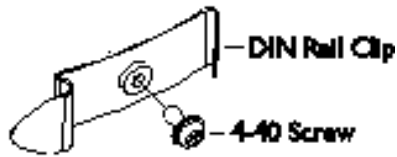

To install the DIN Rail onto the media converter:

1. Position the DIN Rail Clip to the side of the media converter as shown below.

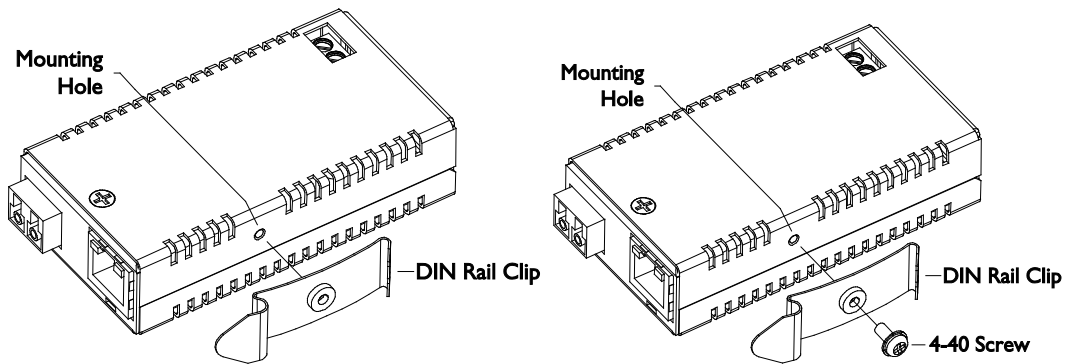

2. Position the 4-40 screw to attach the DIN rail to the media converter as shown above right.

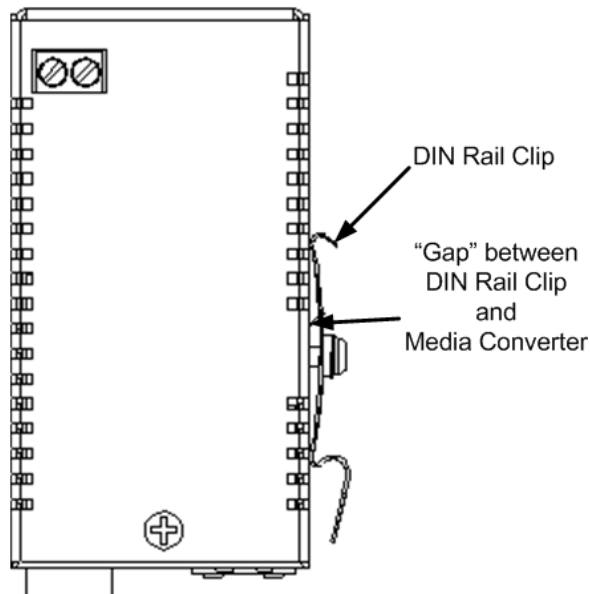

3. Insert and tighten the 4-40 Screw until the DIN Rail Clip appears as shown above. When the DIN Rail Clip is attached, there should be a "gap" between the Clip and the Media Converter as shown above.

Copper and Fiber Ports

The M/GE-ISW-xx-01 front panels are shown below.

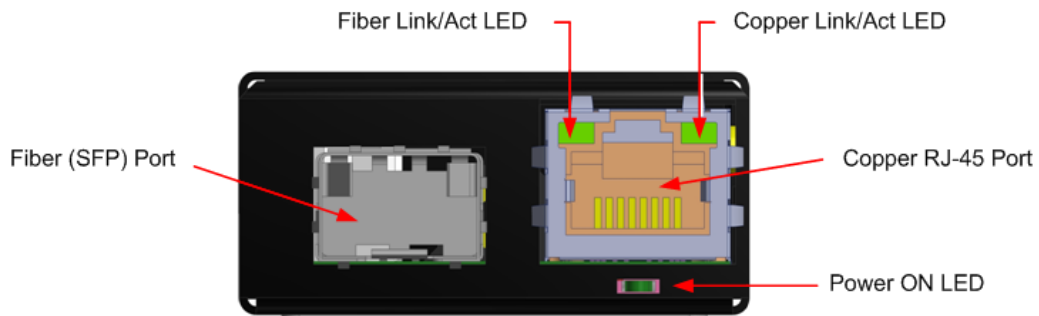

M/GE-ISW-SFP-01

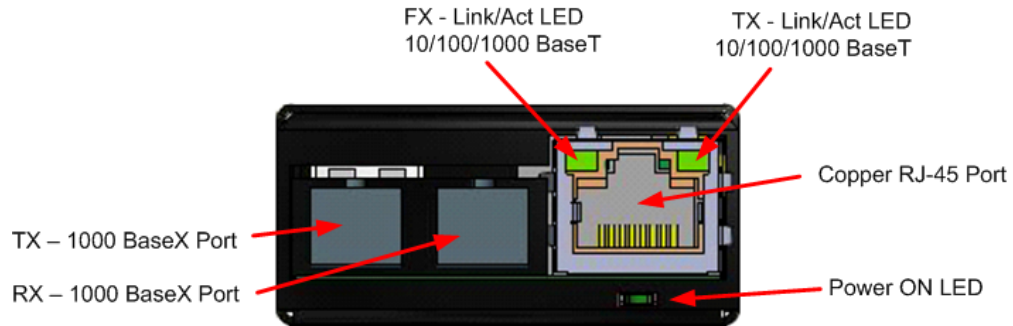

M/GE-ISW-SX-01 (same as M/GE-ISW-LX-01)

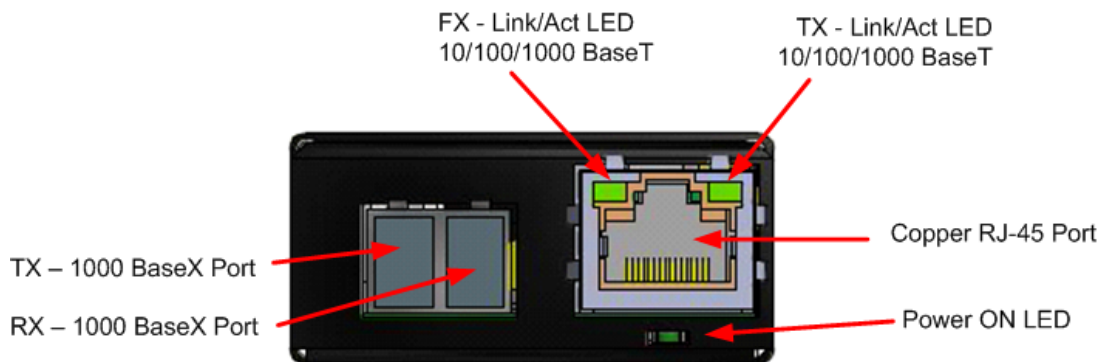

M/GE-ISW-LC-01

Connect Fiber Cables

Full duplex (always ON) is on the fiber side only, therefore, the 512-Bit Rule does not apply. The cable lengths are constrained by the cable requirement.

1. Locate a 100Base-FX fiber cable with male, two-stranded TX to RX connectors installed at both ends.
2. Connect the fiber cable to the M/GE-ISW-xx-01 media converters as follows:
 - Connect the male TX cable connector to the female TX port.
 - Connect the male RX cable connector to the female RX port.
3. Connect the fiber cable to the other device (*media converter, hub, etc.*) as follows:
 - Connect the male TX cable connector to the female RX port.
 - Connect the male RX cable connector to the female TX port.

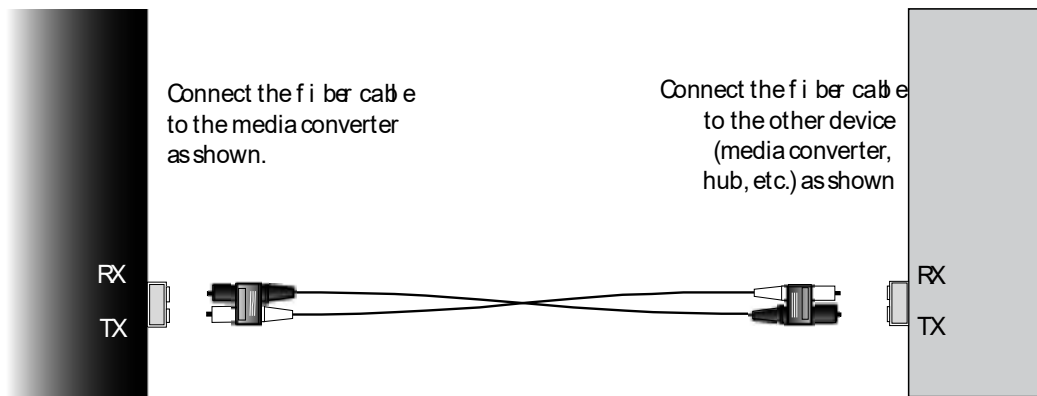

Connect the Twisted-Pair Copper Cable

The AutoCross feature allows either MDI (*straight-through*) or MDI-X (*crossover*) cable connections to be configured automatically, according to network conditions.

- If half-duplex mode is used, refer to the 512-Bit Rule.
- If full-duplex mode is used, the 512-Bit Rule does not apply. The cable lengths are constrained by the cable requirements.

Perform these steps:

1. Locate a 10Base-T or 100Base-TX cable with RJ-45 connectors installed at both ends.
2. Connect the RJ-45 connector at one end of the cable to the RJ-45 port on the M/GE-ISW-xx-01 media converter.
3. Connect the RJ-45 connector at the other end of the cable to the RJ-45 port on the other device (*switch, workstation, etc.*).

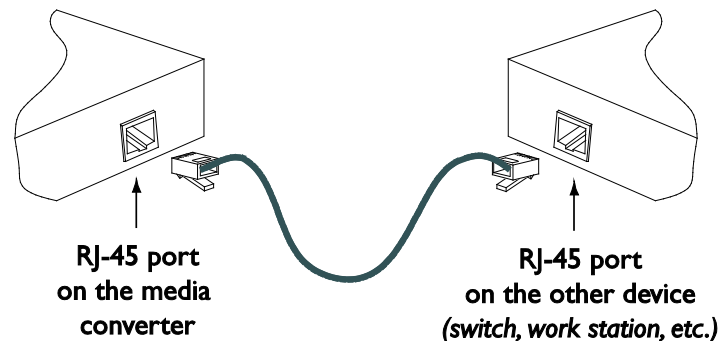

Connecting Power

Connect to DC (12-48 VDC) or AC (22-36 VAC) Power

- 12-48 VDC and 22-36 VAC power input via the Terminal Block
- Pig-tail Cable with Barrel Connector

Note: The Pitch EURO style Terminal block accepts 24-14 gauge wire.

1. Turn OFF the main power source.
2. Strip the power wires to the proper strip length.
3. Loosen the two screws in the Terminal Block. See figure below.
4. Insert the power wires into the Terminal Block as shown below (polarity agnostic).
5. Tighten the screw for each wire.
6. Connect the Barrel Connector end to the main power source.
7. Turn main power source ON. The front panel power LED should light.

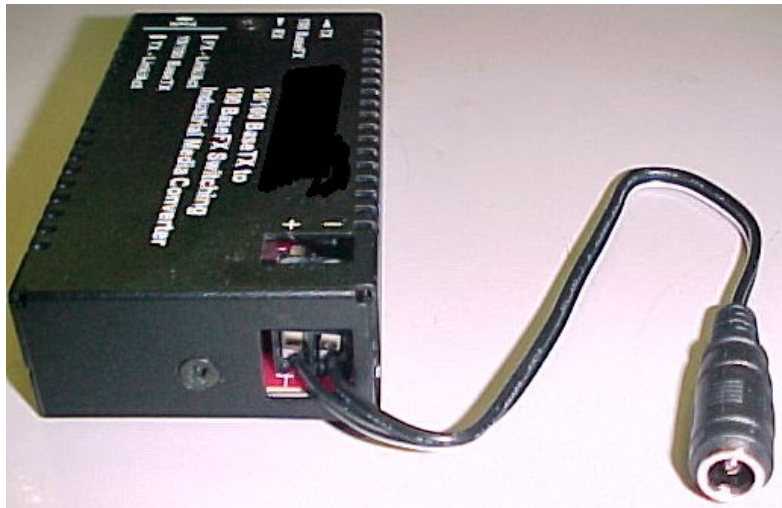

Barrel Connector with Pig-tail Cable connected at Terminal Block

Operation

Status LEDs

Use the status LEDs to monitor the M/GE-ISW-xx-01 media converter operation in the network. The M/GE-ISW-xx-01 front panels are shown in the section “[Copper and Fiber Ports](#)” on page 8. The LEDs are described below:

PWR: Power status.

On = power is on

Off = power is off

Fiber Link/Act: Fiber port link and activity status.

Green On = 1000BASE-X or 100Base-FX fiber link OK

Green Flash = 1000BASE-X or 100Base-FX fiber link OK and activity

Off = Fiber link down

Copper Link/Act: Copper port link and activity status.

Green On = 10/100/1000BASE-T copper link OK

Green Flash = 10/100/1000BASE-T copper link OK and activity

Off = Copper link fail

Fiber Port Mode at Power Up

The fiber port mode is defined by the type of SFP module in the SFP slot at power up:

SFP module in slot at power up	Fiber port mode after power up
No SFP module	1000BASE-X
1000BASE-X SFP module	1000BASE-X
100BASE-FX SFP module	100BASE-FX

Product Features

The M/GE-ISW-xx-01 features include Congestion reduction, Auto-Negotiation, AutoCross™, Link Pass-Through, Automatic link restoration, Distance extension, Rate conversion, and Far-end fault. These features are described below.

Congestion Reduction

The M/GE-ISW-xx-01 media converters do not forward collision signals or error packets from one collision domain to another, resulting in improvements in baseline network performance. In addition, the media converter filters packets destined for local devices, which reduces network congestion.

Auto-Negotiation

The Auto-Negotiation feature is ON permanently for the M/GE-ISW-xx-01 media converters. Auto-Negotiation allows the media converter to configure itself automatically to achieve the best possible mode of operation over a link. It broadcasts speed (10 Mbps, 100 Mbps, or 1000 Mbps) and duplex capabilities (full or half) to the other device and negotiates the best mode of operation. Auto-Negotiation allows quick and easy installation because the optimal link is established automatically.

In a scenario where an auto-negotiation device is linked to a non-negotiating device, the negotiating device via parallel detection recognizes the speed of that second device then establishes the best operating speed (10 Mbps, 100 Mbps, or 1000 Mbps) at half duplex.

AutoCross™

The AutoCross feature allows using either straight-through (MDI) or crossover (MDI-X) copper cables when connecting to 10Base-T, 100Base-TX, or 1000Base-T devices. AutoCross determines the characteristics of the connection and automatically configures the device to link up, regardless of the copper cable configuration, MDI or MDI-X.

Link Pass-Through (LPT)

The Link Pass-Through feature (shown below) allows the media converter to monitor both the fiber and copper RX (receive) ports for loss of signal. In the event of an RX signal loss (1), the media converter will automatically disable the TX (transmit) signal (2), thus “passing through” the link loss (3). The far-end device is automatically notified of the link loss (4), which prevents the loss of valuable data unknowingly transmitted over an invalid link.

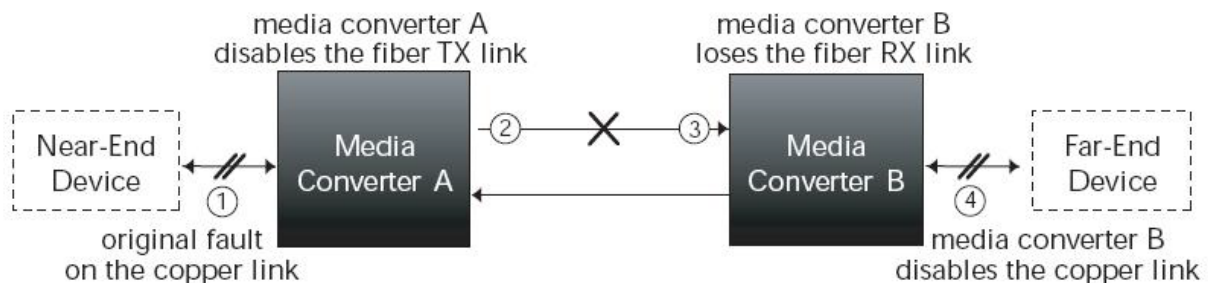

Note: In the link pass-through devices both copper and fiber cables must be installed before the LEDs will light. When LPT is disabled, the link for each media converter port can go up or down, without any dependency on the link status of the media converter's other port.

Active Link Pass-Through (ALPT)

Link Pass Through is a troubleshooting feature that allows the media converter to monitor both the fiber and copper RX ports for loss of signal. With the loss of RX signal on one media port, the converter will automatically disable the TX signal of the other media port, thus “passing through” the link loss.

- End device automatically notified of link loss
- Prevents loss of valuable data unknowingly transmitted over invalid link

Active LPT is the LPT that requires the links to become Active before LPT becomes Active.

With Active LPT there are 2 states: Diagnostic and Active.

Upon power-up, the media converter enters the Diagnostic state. In the Diagnostic state, the link for each of the media converter’s ports can come up independently of each other, just like when LPT is disabled. The Diagnostic state is helpful during first turn-up, before all links of a circuit are connected, as it allows the installer to see each link turn on as the cables are plugged in. It’s also helpful for finding the location of a fault, if one exists.

The media converter remains in the Diagnostic state until the following condition is met: the link status for both of the media converter’s ports is up simultaneously.

After that condition is met, ALPT enters the Active state. It remains in the Active state until the converter is powered down. In the Active state, Active LPT works as shown below (the same as when regular LPT is enabled).

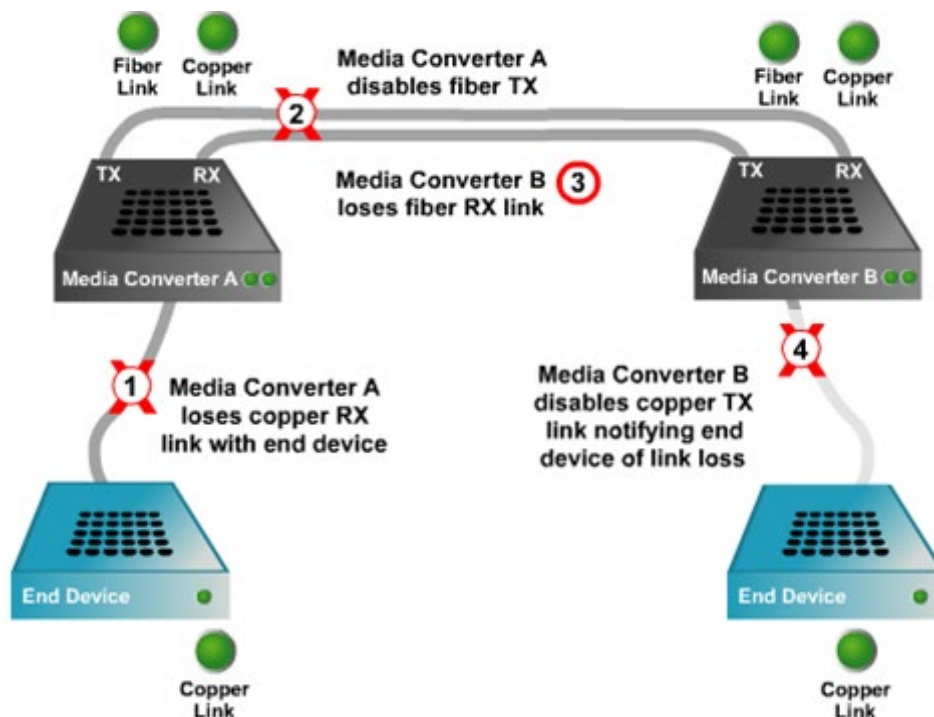

Automatic Link Restoration

The M/GE-ISW-xx-01 will automatically re-establish the link when connected to switches if the link is lost.

Distance Extension

The M/GE-ISW-xx-01 can segment one (1) 10Base-T copper Ethernet and/or 100Base-TX copper Fast Ethernet, and one (1)100Base-FX fiber Fast Ethernet collision domain:

- In a half-duplex Ethernet or Fast Ethernet environment, the M/GE-ISW-xx-01 media converters extend network distances by segmenting collision domains so that the 512-Bit Rule applies separately to each collision domain.
- In a full-duplex Ethernet or Fast Ethernet environment, the M/GE-ISW-xx-01 media converters extend network distances to the physical cable limitations imposed by the selected twisted-pair copper fiber cables.

Rate Conversion

The M/GE-ISW-xx-01 allow connection of 10Mb/s terminal devices on a 10Base-T legacy Ethernet copper network to 100Mb/s terminal devices on a 100Base-TX Fast Ethernet copper network and/or to 100Mb/s terminal devices on a 100Base-FX Fast Ethernet fiber network.

Cable and Optic Specifications

The fiber optic cable physical characteristics must meet or exceed IEEE 802.3ae specification.

Fiber Cable

Bit Error Rate:	<10 ⁻⁹	
Single mode fiber (<i>recommended</i>):	9 μm	
Multimode fiber (<i>recommended</i>):	62.5/125 μm	
Multimode fiber (<i>optional</i>):	100/140, 85/140, 50/125 μm	

Optics

M/GE-ISW-SX-01	850 nm multimode	
Fiber-optic Transmitter Power:	min: -9.5 dBm	max: -4.0 dBm
Fiber-optic Receiver Sensitivity:	min: -17.0 dBm	max: 0.0 dBm
Link Budget:	7.0 dB	
M/GE-ISW-LX-01	1310 nm single mode	
Fiber Optic Transmitter Power:	min: -9.5 dBm	max: -3.0 dBm
Fiber Optic Receiver Sensitivity:	min: -20.0 dBm	max: -3.0 dBm
Link Budget:	10.5 dB	
M/GE-ISW-LC-01	850 nm multimode	
Fiber Optic Transmitter Power:	min: -9.0 dBm	max: 4.0 dBm
Fiber Optic Receiver Sensitivity:	min: -17.0 dBm	max: -3.0 dBm
Link Budget:	8.0 dBm	

Part Number	Copper - Port 10/100/1000Base-TX	Fiber-Optic -Port 100Base-FX
M/GE-ISW-SX-01	RJ-45 100 m (328 ft)*	SC, 850nm multimode (SC) 220 m (.55 miles)*
M/GE-ISW-LX-01	RJ-45 100 m (328 ft)*	SC, 1310nm single mode (SC) 10 km (18.6 miles)*
M/GE-ISW-SFP-01	RJ-45 100 m (328 ft)*	Open SFP
M/GE-ISW-LC-01	RJ-45 100 m (328 ft)*	LC, 850 nm multimode (LC) 220 km (136mi) on 62.5 micron fiber* 550 km (341 mi) on 50 micron fiber*

* Typical maximum cable distance. Actual distance depends on the network installation's physical characteristics.

Copper Cable

Category 3: (Minimum requirement for 10 Mb/s operation)

Gauge	24 to 22 AWG
Attenuation	11.5 dB/100m @ 5-10 MHz
Maximum Cable Distance	100 meters

Category 5: (Minimum requirement for 100 Mb/s operation)

Gauge	24 to 22 AWG
Attenuation	22.0 dB /100m @ 100 MHz
Maximum Cable Distance	100 meters

- Straight-through or crossover twisted-pair cable may be used.
- Shielded (STP) or unshielded (UTP) twisted-pair cable may be used.
- Pins 1&2 and 3&6 are the two active pairs in an Ethernet network.
- Use only dedicated wire pairs for the active pins:
(e.g., blue/white & white/blue, orange/white & white/orange, etc.)
- Do not use flat or silver satin wire.

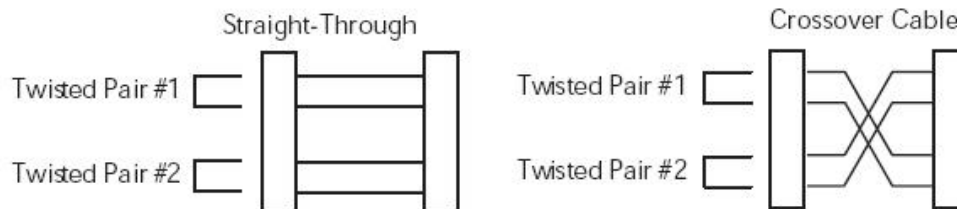

Category 5e: The category 5e specification improves on the category 5 specification by tightening some crosstalk specifications and introducing new crosstalk specifications that were not present in the original category 5 specification. The bandwidth of category 5 and 5e is the same (100 MHz) and the physical cable construction is the same, and the reality is that most Cat5 cable meets Cat5e specifications, though it is not tested or certified as such. The cable standard provides performance of up to 100 MHz and is suitable for 10BASE-T, 100BASE-TX (Fast Ethernet), and 1000BASE-T (Gigabit Ethernet). 10BASE-T and 100BASE-TX Ethernet connections require two wire pairs. 1000BASE-T Ethernet connections require four wire pairs. Cat 5e is the minimum for 1000 Mbps.

Category 6 cable, commonly referred to as Cat 6, is a standardized cable for Gigabit Ethernet and other network physical layers that is backward compatible with the Category 5/5e and Category 3 cable standards. Compared to Cat 5 and Cat 5e, Cat 6 provides more stringent specifications for crosstalk and system noise. The Cat 6 cable standard provides performance of up to 250 MHz and is suitable for 10BASE-T, 100BASE-TX (Fast Ethernet), 1000BASE-T/1000BASE-TX (Gigabit Ethernet) and 10GBASE-T (10-Gigabit Ethernet). Category 6 cable has a reduced maximum length when used for 10GBASE-T.

Like most of the earlier twisted-pair cables, Category 6 cable contains four twisted wire pairs. Attenuation, Near End crosstalk (NEXT), and PSNEXT (Power Sum NEXT) in Cat 6 cable and connectors are all much lower than Cat 5 or Cat 5e, which uses 24 AWG wire. The increase in performance with Cat 6 comes mainly from increased (22 AWG) wire size. Because the conductor sizes are generally the same, Cat 6 jacks may also be used with Cat 5e cable.

Category 6 cable can be identified by the printing on the side of the cable sheath. Cat 6 patch cables are normally terminated in 8P8C modular connectors. If Cat 6 rated patch cables, jacks, and connectors are not used with Cat 6 wiring, overall performance is degraded to that of the cable or connector.

Connectors use either T568A or T568B pin assignments; although performance is comparable provided both ends of a cable are the same, T568B is a deprecated standard in the US and no longer supported by TIA.

Category 6a cable, or Augmented Category 6, is characterized to 500 MHz and has improved alien crosstalk characteristics, allowing 10GBASE-T to be run for the same distance as previous protocols.

The latest standard from the TIA for enhanced performance standards for twisted pair cable systems was defined in February 2008 in ANSI/TIA/EIA-568-B.2-10. Category 6a is defined at frequencies up to 500 MHz - twice that of Cat. 6. Category 6a performs at improved specifications, in particular in the area of alien crosstalk, as compared to Cat 6 UTP (unshielded twisted pair), which exhibited high alien noise in high frequencies.

The global cabling standard ISO/IEC 11801 has been extended by the addition of amendment 2, which defines new specifications for Cat 6A components and Class EA permanent links. These new global Cat 6A/Class EA specifications require a new generation of connecting hardware, which offer superior performance compared to existing products based on the American TIA standard.

Note the performance difference between ISO/IEC and EIA/TIA component specifications for the NEXT transmission parameter. At a frequency of 500 MHz, an ISO/IEC Cat 6A connector performs 3 dB better than a Cat 6A connector that conforms to the EIA/TIA specification. The 3 dB represents a 100% increase of near-end crosstalk noise reduction when measured in absolute magnitudes.

Maximum Length

When used for 10/100/1000BASE-T, the maximum allowed length of a Cat 6 cable is 100 meters or 328 feet. This consists of 90 meters (300 ft) of solid "horizontal" cabling between the patch panel and the wall jack, plus 10 meters (33 ft) of stranded patch cable between each jack and the attached device. Since stranded cable has higher attenuation than solid cable, exceeding 10 meters of patch cabling will reduce the permissible length of horizontal cable.

When used for 10GBASE-T, Cat 6 cable's maximum length is 55 meters (180 ft) in a favorable alien crosstalk environment, but only 37 meters (121 ft) in a hostile alien crosstalk environment, such as when many cables are bundled together. However, because the effects of alien crosstalk environments on cables are difficult to determine prior to installation, it is highly recommended that all Cat 6 cables being used for 10GBASE-T are electrically tested once installed. With its improved specifications, Cat6 A does not have this limitation and can run 10GBASE-T at 100 meters (330 ft) without electronic testing.

Installation Notes

Category 6 and 6a cable must be properly installed and terminated to meet specifications. The cable must not be kinked or bent too tightly (the bend radius should be at least four times the outer diameter of the cable). The wire pairs must not be untwisted, and the outer jacket must not be stripped back more than 1/2 inch (1.27 cm). All shielded cables must be grounded for safety and effectiveness and a continuous shield connection maintained from end to end. Ground loops develop when there is more than one ground connection and the difference in common mode voltage potential at these ground connections introduces noise into the cabling. Note that 23 or 24 AWG wire is allowed if the ANSI/TIA-568-B.2-1 performance specifications are met. The figure below shows the pins on plug face; note that the socket is the reverse of the plug pinout shown below. For more information, see the TIA web site or the IEEE web site.

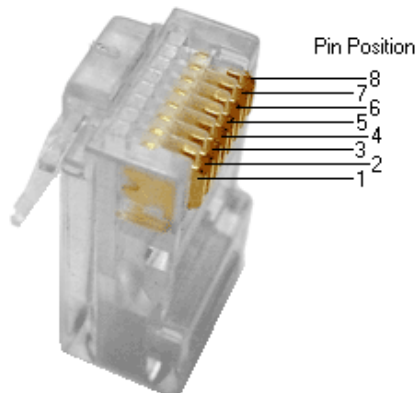

Category 6 Plug Face Pins

Troubleshooting Cat 6 & Cat 6A Structured Copper Cabling Systems

If a Category 6 cabling system does not meet the electrical requirements for supporting 10GBASE-T applications, see the TSB-155 provides guidelines designed to mitigate the alien crosstalk between the target pair and the disturbing pairs of Category 6 channels and permanent links. Annex B of TSB-155 outlines the following mitigation actions most appropriate for individual situations:

- Use Category 6 shielded or Category 6A patch cords;
- Replace Category 6 connectors with Category 6A connectors;
- Use non-adjacent patch panel positions;
- Separate equipment cords and patch cords;
- Unbundle or more loosely bundle the horizontal cabling; and
- Reconfigure the cross-connect as an interconnect.

Technical Specifications

For use with M/GE-ISW-xx-01 media converters.

Standards Compliance	IEEE802.3, IEEE 802.3u, IEEE 802.3ab, IEEE 802.3z, IEEE 802.3x
Regulatory Compliance for Emission	FCC Class A; EN55022 Class A
Regulatory Compliance for Immunity	EN55024
Safety Compliance	CE Mark
Data Rate	RJ-45: 10 Mbps, 100 Mbps, and 1000 Mbps SFP: One 100/1000BASE-X dual speed SFP slot
Max Frame Size	10,240 bytes
Unicast MAC addresses	1K
Dimensions (width x depth x height)	1.8" x 3.33" x 0.85"(45.7mm x 85 mm x 22 mm)
Weight	0.40 lbs (0.18 kg)
Power Consumption	1.2W
Power Source	12 - 48 VDC or 22-36 VAC \pm 10%
Power Input	2-pin terminal block Unit accepts 12 – 48 VDC or 24 – 36VAC (External power supplies sold separately)
Ingress Protection	IP20
Operating Temp	-40°C to +75°C (-40°F to +167°F)
Humidity	5% to 95%, non-condensing
Operating Humidity	5% to 95% (non-condensing)
Altitude	0-10,000 feet
MTBF*	Greater than 41,680 hours ((MIL-HDBK-217F) Greater than 114,580 hours (Bellcore7 V5.0)
Warranty	Lifetime

* MTBF calculation is based on use with a 50,000 hour power supply.

CAUTION: Copper based media ports, e.g., Twisted Pair (TP) Ethernet, USB, RS232, RS422, RS485, DS1, DS3, Video Coax, etc., are intended to be connected to intrabuilding (inside plant) link segments that are not subject to lightening transients or power faults. Copper-based media ports, e.g., Twisted Pair (TP) Ethernet, USB, RS232, RS422, RS485, DS1, DS3, Video Coax, etc., are NOT to be connected to interbuilding (outside plant) link segments that are subject to lightening transients or power faults. Failure to observe this caution could result in damage to equipment.

WARNING: Visible and invisible laser radiation when open. Do not stare into the beam or view directly with optical instruments. Failure to observe this warning could result in an eye injury or blindness.

WARNING: Use of controls, adjustments, or the performance of procedures other than those specified herein could result in hazardous radiation exposure.

The information in this manual is subject to change. For the most current information, view the online [user guide](#).

Troubleshooting

If the media converter fails, isolate and correct the fault by determining the answers to the following questions and then taking the indicated action:

1. Is the PWR (power on) LED lit?
NO
 - Is the pig tail cable properly connected to the converter? See [Connecting Power](#) on page 10.
 - Is the barrel connector properly connected to the main power source?
 - Is the main power source properly connected to the appropriate power?
 - Contact Tech Support.YES
 - Proceed to step 2.
2. Is the RX (copper link) LED lit?
NO
 - Check the twisted-pair copper cables for proper connection. See [Connect the Twisted-Pair Copper Cable](#) on page 9.
 - Contact Tech Support.YES
 - Proceed to step 3.
3. Is the LKF (fiber link) LED lit?
NO
 - Check the fiber cables for proper connection. See [Connect Fiber Cables](#) on page 9.
 - Verify that the fiber cables on the media converter are properly connected to the ports on the other device.
 - Verify the correct SFP is used, reseal the SFP if applicable.
 - Contact Tech Support.YES
 - Proceed to step 4.
4. Is the TX (copper receive) LED flashing?
NO
 - If there is activity on the copper port, disconnect and reconnect the copper cable to reinitialize.
 - Restart the workstation to restart the initialization process.
 - Contact Tech Support.YES
 - Contact Tech Support.

Compliance Information

CE Declaration of Conformity

Manufacture's Name: Lantronix, Inc.

Manufacture's Address: 48 Discovery, Suite 250, Irvine, California 92618 USA

Declares that the products:

M/GE-ISW-SFP-01, M/GE-ISW-SX-01, M/GE-ISW-LC-01, M/GE-ISW-LX-01

Conform to the following Product Regulations:

FCC Part 15 Class A, EN 55032:2012, EN 55032:2015 (Class A), EN 55035:2017, EN 55024:2010
Directive 2014/30/EU

Low-Voltage Directive 2014/35/EU

IEC /EN 60950-1:2006+A2:2013

2011/65/EU EN 50581:2012

IEC/EN 62368-1:2018

With the technical construction on file at the above address, this product carries the CE Mark

I, the undersigned, hereby declare that the equipment specified above conforms to the above Directive(s) and Standard(s).

Place: Irvine, California

Date: April 27, 2023

Signature: *Eric Bass*

Full Name: Eric Bass

Position: Vice President of Engineering

FCC regulations

This equipment has been tested and found to comply with the limits for a Class A digital device, pursuant to Part 15 of the FCC rules. These limits are designed to provide reasonable protection against harmful interference when the equipment is operated in a commercial environment. This equipment generates, uses, and can radiate radio frequency energy and, if not installed and used in accordance with the instruction manual, may cause harmful interference to radio communications. Operation of this equipment in a residential area is likely to cause harmful interference, in which case the user will be required to correct the interference at the user's own expense.

Canadian regulations

This digital apparatus does not exceed the Class A limits for radio noise for digital apparatus set out on the radio interference regulations of the Canadian Department of Communications.

Le présent appareil numérique n'émet pas de bruits radioélectriques dépassant les limites applicables aux appareils numériques de la Class A prescrites dans le Règlement sur le brouillage radioélectrique édicté par le ministère des Communications du Canada.

European regulations

Warning

This is a Class A product. In a domestic environment this product may cause radio interference in which case the user may be required to take adequate measures.

Achtung !

Dieses ist ein Gerät der Funkstörgrenzwertklasse A. In Wohnbereichen können bei Betrieb dieses Gerätes Rundfunkstörungen auftreten. In diesem Fall ist der Benutzer für Gegenmaßnahmen verantwortlich.

Attention !

Ceci est un produit de Classe A. Dans un environnement domestique, ce produit risque de créer des interférences radioélectriques, il appartiendra alors à l'utilisateur de prendre les mesures spécifiques appropriées.



In accordance with European Union Directive 2002/96/EC of the European Parliament and of the Council of 27 January 2003, Lantronix will accept post usage returns of this product for proper disposal. The contact information for this activity can be found in the 'Contact Us' portion of this document.



CAUTION: RJ connectors are NOT INTENDED FOR CONNECTION TO THE PUBLIC TELEPHONE NETWORK. Failure to observe this caution could result in damage to the public telephone network.

Der Anschluss dieses Gerätes an ein öffentliches Telekommunikationsnetz in den EGMitgliedstaaten verstösst gegen die jeweiligen einzelstaatlichen Gesetze zur Anwendung der Richtlinie 91/263/EWG zur Angleichung der Rechtsvorschriften der Mitgliedstaaten über Telekommunikationsendeinrichtungen einschliesslich der gegenseitigen Anerkennung ihrer Konformität.

**Lantronix Corporate Headquarters**

48 Discovery, Suite 250
Irvine, CA 92618, USA
Toll Free: 800-526-8766
Phone: 949-453-3990
Fax: 949-453-3995

Technical Support

Online: <https://www.lantronix.com/technical-support/>

Sales Offices

For a current list of our domestic and international sales offices, go to the Lantronix web site at www.lantronix.com/about/contact.