

User's Guide

CRS2F31xx-100 Slide-in-Module Media Converter RS-232 to Fiber

Transition Networks CRS2F31xx-100 series media converters are designed to be installed in the *PointSystem™* chassis and connect copper RS-232 cable to fiber-optic cable at asynchronous data rates up to 115 kB/s.

The CRS2F31xx-100 is designed to be installed in pairs where one is the local media converter and the other is the remote.

Part Number	Port One - Copper	Port Two - Duplex Fiber-Optic
CRS2F3111-100	RS-232 15 m (50 ft)	ST, 1300 nm multimode 2 km (1.2 miles)*
CRS2F3113-100	RS-232 15 m (50 ft)	SC, 1300 nm multimode 2 km (1.2 miles)*
CRS2F3114-100	RS-232 15 m (50 ft)	SC, 1310 nm single mode 20 km (12.4 miles)*
CRS2F3115-100	RS-232 15 m (50 ft)	SC, 1310 nm single mode 40 km (24.8 miles)*
CRS2F3129-100	RS-232 15 m (50 ft)	SC, 1310 TX/1550 RX nm single mode 20 km (12.4 miles)**
CRS2F3129-101	RS-232 15 m (50 ft)	SC, 1550 TX/1310RX nm single mode 20 km (12.4 miles)**
CRS2F3129-102	RS-232 15 m (50 ft)	SC, 1550 TX/1310RX nm single mode 40 km (12.4 miles)**
CRS2F3129-103	RS-232 15 m (50 ft)	SC, 1550 TX/1310RX nm single mode 40 km (24.8miles)**

**Install CRS2F3129-100/101 or CRS2F3129-102/103 in the same network where one is the local converter and the other is the remotec onverter.

* Typical maximum cable distance.
Actual distance is dependent upon the physical characteristics of the network installation.

Installation	.2
Operation	.6
Cable Specifications	.7
Technical Specifications	.8
Troubleshooting	.9
Contact Us	.11
Compliance Information	.12

Installation

CAUTION: Wear a grounding device and observe electrostatic discharge precautions when setting the switches and jumper. Failure to observe this caution could result in damage to, and subsequent failure of, the media converter.

Set the DTE/DCE Switch

The DTE/DCE switch is located on the side of the media converter. How the DTE/DCE switch is set depends on the type of device connected to the media converter:

- DTE (*Data Terminal Equipment*).
- DCE (*Data Communication Equipment*).

... and the type of RS-232 cable:

- Straight-through configuration cable.
- Null-modem configuration cable.

Using Straight-Through RS-232 Cable

Set the switch to DTE configuration if the media converter is connected to a DCE device via a straight-through RS-232 cable.

Set the switch to DCE configuration if the media converter is connected to a DTE device via a straight-through RS-232 cable.

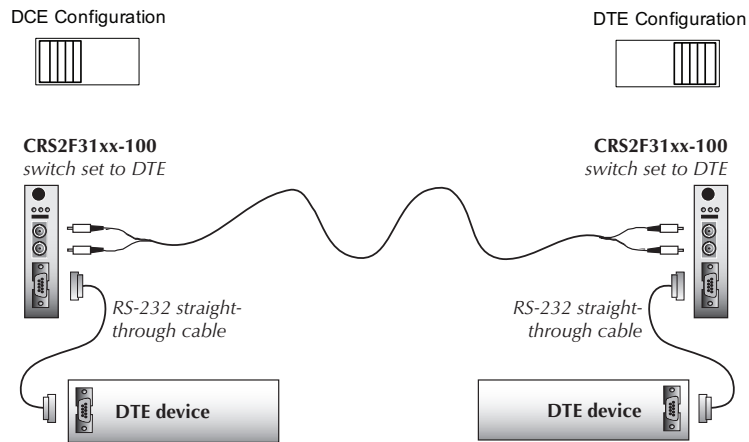

Installation -- Continued

Using Null-Modem RS-232 Cable

Set the switch to DCE configuration if the media converter is connected to a *DCE* device via a null-modem RS-232 cable.

Set the switch to DTE configuration if the media converter is connected to a DTE device via a null-modem RS-232 cable.

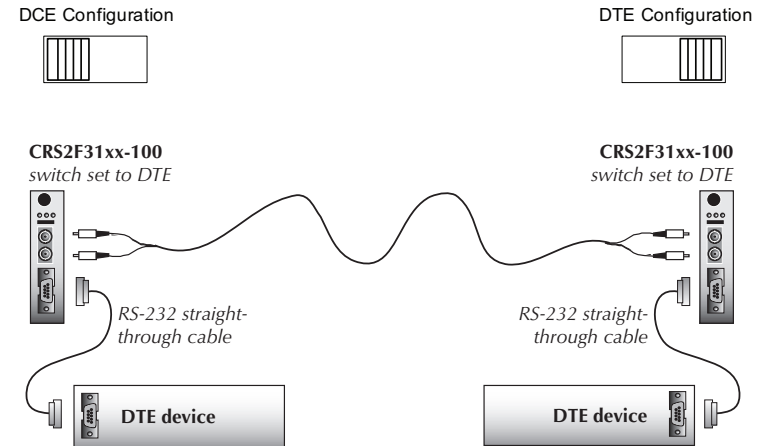

Set the Loop-Back Switch

The loop-back switch is located on the front panel of the media converter and is used to debug network faults.

To set the switch, use a small flat-blade screwdriver or a similar device.

- Norm** Set the switch to “Norm” for normal operation.
- Loop** Set the switch to “Loop” to enable both fiber and copper loop-back.

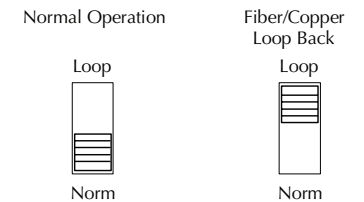

Installation -- Continued

CAUTION: Wear a grounding device and observe electrostatic discharge precautions when setting the hardware/software jumper and installing the media converter. Failure to observe this caution could result in damage to, and subsequent failure of, the media converter.

Set the Hardware/Software Jumper

- The jumper is located on the circuit board.
- Use small needle-nose pliers to set the jumper.

Hardware The media converter mode is determined by the switch settings.

Software The media converter mode is determined by the most-recently saved, on-board microprocessor settings.

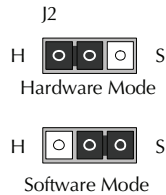

Installing the Slide-in-Module

To install the CRS2F31xx-100 media converter slide-in-module:

1. Locate an empty installation slot on the *PointSystem™* chassis.
2. Carefully slide the slide-in-module into the installation slot, aligning the module with the installation guides.
3. Ensure that the module is firmly seated inside the chassis.
4. Push in and rotate the attached panel fastener screw clockwise to secure the module to the chassis front.

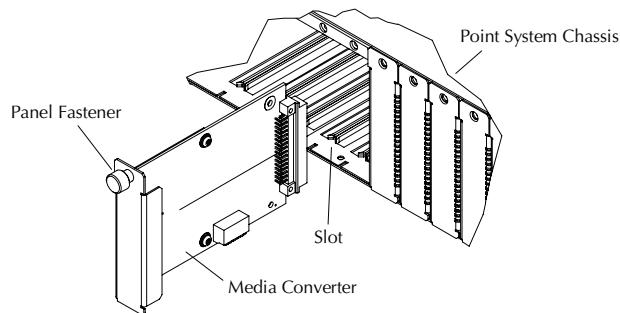

Power the Media Converter

The media converter is powered through the *PointSystem™* chassis.

Installation -- Continued

Install the Fiber Cable

1. Locate or build fiber cable with male, two-stranded TX to RX connectors installed at both ends.
2. Connect the fiber cables to the first CRS2F31xx-100 media converter as described:
 - Connect the male TX cable connector to the female TX port.
 - Connect the male RX cable connector to the female RX port.
3. Connect the fiber cables to the other CRS2F31xx-100 media converter as described:
 - Connect the male TX cable connector to the female RX port.
 - Connect the male RX cable connector to the female TX port.

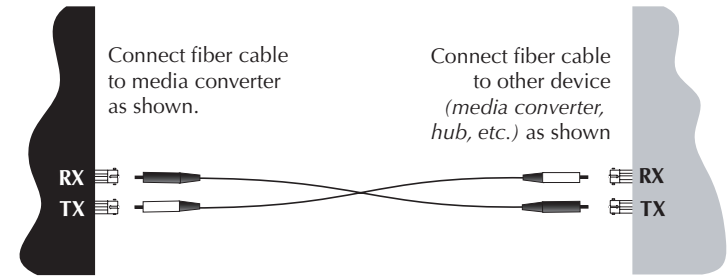

Install the Copper Cable

Note: Shielded RS-232 cables are required for EMC compliance.

1. Locate or build RS-232 cables with a female connector for the media converter end and the correct gender connector for the DTE/DCE device at the other end. And with either straight-through or null-modem cable configuration.
2. Connect the female RS-232 connector at one end of cable to the male RS-232 port on the first CRS2F21-100 media converter.
3. Connect the RS-232 connector at the other end of the cable to the RS-232 port on the DTE/DCE device.

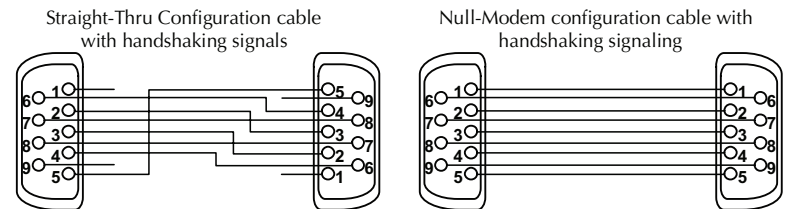

(Optional configuration: no connection pin 9)

(Requirements for different equipment may vary)

Operation

After installation, the media converter should function without operator intervention. Use the status LEDs to monitor the media converter operation in the network.

PWR	On	The media converter is connected to external power.
FL	On	A link has been established with the fiber connector.
	Flashing	The media converter is in loop-back mode.
RX	Flashing	The RS-232 connector is receiving data.

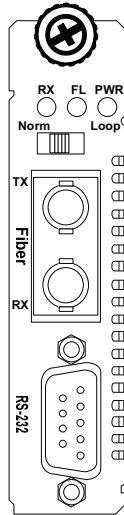

Remote Management

The CRS2F31xx-100 can remotely manage the SRS2F31xx-100 (*the stand-alone version of the media converter*) or another CRS2F31xx-100. For example, a local CRS2F3111-100 converter (*that is installed in a managed Transition Networks PointSystem™ chassis*) is connected, via fiber, to a remote SRS2F3111-100 converter.

The SNMP section (*below*) lists the commands that can be used to monitor and manage both the local and remote media converter.

Note: In a managed network, both the local and remote media converters must be set to “software” mode.

SNMP

Use SNMP at an attached terminal or at a remote location to monitor the media converter by monitoring:

- Local/remote fiber link status
- Local/remote hardware/software mode
- Local/remote loop-back

Also, use SNMP to enter network commands for:

- Local/remote loop-back

See the on-line documentation that comes with Transition Networks *FocalPoint™* software for applicable commands and usage at www.transition.com.

Cable Specifications

Fiber Cable

Bit Error Rate:	<10 ⁻⁹
Single mode fiber (<i>recommended</i>):	9 μm
Multimode fiber (<i>recommended</i>):	62.5/125 μm
Multimode fiber (<i>optional</i>):	100/140, 85/140, 50/125 μm
CRS2F3111-100	1300 nm multimode
Fiber Optic Transmitter Power:	min: -19.0 dBm max: -14.0 dBm
Fiber Optic Receiver Sensitivity:	min: -30.0 dBm max: -14.0 dBm
Link Budget:	11.0 dB
CRS2F3113-100	1300 nm multimode
Fiber Optic Transmitter Power:	min: -19.0 dBm max: -14.0 dBm
Fiber Optic Receiver Sensitivity:	min: -30.0 dBm max: -14.0 dBm
Link Budget:	11.0 dB
CRS2F3114-100	1310 nm single mode
Fiber-optic Transmitter Power:	min: -15.0 dBm max: -8.0 dBm
Fiber-optic Receiver Sensitivity:	min: -31.0 dBm max: -8.0 dBm
Link Budget:	16.0 dB
CRS2F3115-100	1310 nm single mode
Fiber-optic Transmitter Power:	min: -8.0 dBm max: -2.0 dBm
Fiber-optic Receiver Sensitivity:	min: -34.0 dBm max: -7.0 dBm
Link Budget:	26.0 dB
CRS2F3129-100	1310TX/1550RX nm single mode
CRS2F3129-101	1550TX/1310RX nm single mode
Fiber-optic Transmitter Power:	min: -13.0 dBm max: -6.0 dBm
Fiber-optic Receiver Sensitivity:	min: -32.0 dBm max: -3.0 dBm
Link Budget:	19.0 dB
CRS2F3129-102	1310TX/1550RX nm single mode
CRS2F3129-103	1550TX/1310RX nm single mode
Fiber-optic Transmitter Power:	min: -8.0 dBm max: -3.0 dBm
Fiber-optic Receiver Sensitivity:	min: -33.0 dBm max: -3.0 dBm
Link Budget:	25.0 dB

RS-232 Copper Cable

CRS2F3115-100

Gauge: 24 to 22 AWG

Maximum Data Rate (*asynchronous*): 115 kB/s

Maximum Cable Distance: 15 m (50 ft.)

RS-232 Signals:

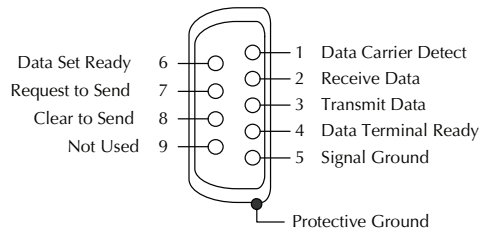

Technical Specifications

For use with Transition Networks Model CRS2F31xx-100 or equivalent

Data Rate	115 kB/s (<i>asynchronous</i>)
Dimensions	3.4" x 5.0" x 0.86" (86 mm x 127 mm x 22 mm)
Weight	3 oz. (91 g) approximately
Power Consumption	5 Watts
MTBF	2,613,860 hours (MIL217F2 V5.0) (MIL-HDBD-217F) 6,569,957 hours (Bellcore7 V5.0)
Environment	Tmra*: 0 to 50°C (32° to 122° F) Storage Temp: -40° to +85°C (-40° to +185°F) Humidity: 5 to 95%, non condensing Altitude: 0 to 10,000 feet
Warranty	Lifetime

*Manufacturer's rated ambient temperature. Tmra range for this slide-in-module depends on the physical characteristics and the installation configuration of the Transition Networks PointSystem™ chassis in which this slide-in-module will be installed.

WARNING: Visible and invisible laser radiation when open. Do not stare into the beam or view the beam directly with optical instruments. Failure to observe this warning could result in an eye injury or blindness.

WARNING: Use of controls, adjustments or the performance of procedures other than those specified herein may result in hazardous radiation exposure.

Copper based media ports, e.g., Twisted Pair (TP) Ethernet, USB, RS232, RS422, RS485, DS1, DS3, Video Coax, etc., are intended to be connected to intra-building (inside plant) link segments that are not subject to lightening transients or power faults. Copper based media ports, e.g., Twisted Pair (TP) Ethernet, USB, RS232, RS422, RS485, DS1, DS3, Video Coax, etc., are NOT to be connected to inter-building (outside plant) link segments that are subject to lightening transients or power faults.

Troubleshooting

If the media converter fails, isolate and correct the failure by determining the answers to the following questions and then taking the indicated action:

- Is the P (*power*) LED illuminated?
 - NO
 - Is the media converter inserted properly into the chassis?
 - Is the power cord properly installed in the chassis and in the grounded AC outlet?
 - Does the grounded AC outlet provide power?
 - Contact Tech Support: 1-800-260-1312, Int'l: 00-1-952-941-7600.
 - YES
 - Proceed to step 2.
- Is the RX (*copper*) LED flashing?
 - NO
 - Disconnect and reconnect the RS-232 copper cable to restart the initialization process.
 - Restart the attached device on the other end of the RS-232 cable to restart the initialization process.
 - Contact Tech Support: 1-800-260-1312, Int'l: 00-1-952-941-7600.
 - YES
 - Proceed to step 3.
- Is the FL (*fiber*) LED illuminated?
 - NO
 - Check the fiber cables for proper connection.
 - Verify that the TX and RX cables on the media converter are connected to the RX and TX ports, respectively, on the other media converter.
 - Contact Tech Support: 1-800-260-1312, Int'l: 00-1-952-941-7600.
 - YES
 - Proceed to step 4.
- Is the FL (*fiber*) LED flashing?
 - YES
 - The media converter is in loop-back mode. To disable the loop-back function in "Hardware" mode, set the loop-back switch to the "Norm" position. In "Software" mode, at the SNMP interface, select "disable loop-back" option.
 - Contact Tech Support: 1-800-260-1312, Int'l: 00-1-952-941-7600.
 - NO
 - Proceed to step 5.

5. Is Data Transfer Failing?

YES

- Verify the local copper connection by starting a local copper loop-back (*hardware mode: set the loop-back switch on the local media converter to "loop", software mode: enter the local copper loop-back command*) and then use a bit error test unit to run a bit error test.

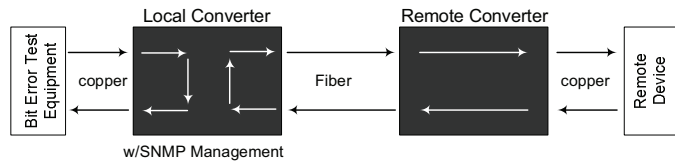

- Verify the local fiber connection by starting a remote fiber loop-back (*hardware mode: set the loop-back switch on the remote media converter to "loop", software mode: enter the remote fiber loop-back command*) and then use a bit error test unit to run a bit error test.

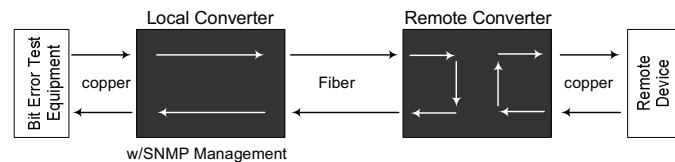

- Verify the remote copper connection by starting a remote copper loop-back (*hardware mode: set the loop-back switch on the remote media converter to "loop", software mode: enter the remote copper loop-back command*) and then use a bit error test unit on the remote end to run a bit error test.

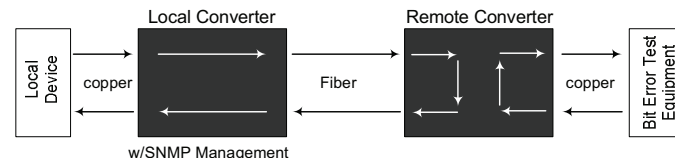

- Verify remote fiber connection by starting a local copper loop-back (*hardware mode: setting the loop-back switch on the local media converter to "loop", software mode: enter the local fiber loop-back command*) and then use a bit error test unit on the remote end to run a bit error test.

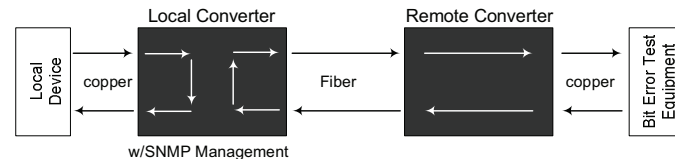

NO

- Contact Technical Support: US/Canada: 1-800-260-1312, International: 00-1-952-941-7600.

Contact Us

Technical Support

Technical support is available 24 hours a day.
 US and Canada: 1-800-260-1312
 International: 00-1-952-941-7600

Transition Now

Chat live via the Web with Transition Networks Technical Support.
 Log onto www.transition.com and click the Transition Now link.

Web-Based Seminars

Transition Networks provides seminars via live web-based training.
 Log onto www.transition.com and click the Learning Center link.

E-Mail

Ask a question anytime by sending an e-mail to our technical support staff.
techsupport@transition.com

Address

Transition Networks
 10900 Red Circle Drive Minnetonka MN 55343, U.S.A.
 telephone: 952-941-7600
 toll free: 800-526-9267
 fax: 952-941-2322

	<h3>Declaration of Conformity</h3>
	<p>Name of Mfg: Transition Networks 10900 Red Circle Drive Minnetonka MN 55343 U.S.A.</p> <p>Model: CRS2F31xx-10x Series Media Converter</p> <p>Part Number: CRS2F3111-100, CRS2F3113-100, CRS2F3114-100, CRS2F3115-100, CRS2F3129-100, CRS2F3129-101, CRS2F3129-102, CRS2F3129-103</p> <p>Regulation: EMC Directive 89/336/EEC</p> <p>Purpose: To declare that the CRS2F31xx-10x to which this declaration refers is in conformity with the following standards. CISPR 22: 1993; EN 55022:1998 Class A; FCC Part 15 Subpart B; EN 55024: 1998; 21 CFR subpart J</p> <p>I, the undersigned, hereby declare that the equipment specified above conforms to the above Directive(s) and Standard(s).</p> <p align="center"> Stephen Anderson, Vice-President of Engineering </p> <p align="right"> July 2008 Date </p>

Compliance Information

CISPR22/EN55022 Class A + EN55024

CE Mark

FCC Regulations

This equipment has been tested and found to comply with the limits for a Class A digital device, pursuant to part 15 of the FCC rules. These limits are designed to provide reasonable protection against harmful interference when the equipment is operated in a commercial environment. This equipment generates, uses, and can radiate radio frequency energy and, if not installed and used in accordance with the instruction manual, may cause harmful interference to radio communications. Operation of this equipment in a residential area is likely to cause harmful interference, in which case the user will be required to correct the interference at the user's own expense.

Canadian Regulations

This digital apparatus does not exceed the Class A limits for radio noise for digital apparatus set out on the radio interference regulations of the Canadian Department of Communications. Le présent appareil numérique n'émet pas de bruits radioélectriques dépassant les limites applicables aux appareils numériques de la Class A prescrites dans le Règlement sur le brouillage radioélectrique édicté par le ministère des Communications du Canada.

European Regulations

Warning

This is a Class A product. In a domestic environment this product may cause radio interference in which case the user may be required to take adequate measures.

Achtung !

Dieses ist ein Gerät der Funkstörgrenzwertklasse A. In Wohnbereichen können bei Betrieb dieses Gerätes Rundfunkstörungen auftreten. In diesem Fall ist der Benutzer für Gegenmaßnahmen verantwortlich.

Attention !

Ceci est un produit de Classe A. Dans un environnement domestique, ce produit risque de créer des interférences radioélectriques, il appartiendra alors à l'utilisateur de prendre les mesures spécifiques appropriées.



In accordance with European Union Directive 2002/96/EC of the European Parliament and of the Council of 27 January 2003, Transition Networks will accept post usage returns of this product for proper disposal. The contact information for this activity can be found in the 'Contact Us' portion of this document.



CAUTION: RJ connectors are NOT INTENDED FOR CONNECTION TO THE PUBLIC TELEPHONE NETWORK. Failure to observe this caution could result in damage to the public telephone network.

Der Anschluss dieses Gerätes an ein öffentliches Telekommunikationsnetz in den EG-Mitgliedstaaten verstößt gegen die jeweiligen einzelstaatlichen Gesetze zur Anwendung der Richtlinie 91/263/EWG zur Angleichung der Rechtsvorschriften der Mitgliedstaaten über Telekommunikationsendeinrichtungen einschliesslich der gegenseitigen Anerkennung ihrer Konformität.

Trademark Notice

All trademarks and registered trademarks are the property of their respective owners.

Copyright Restrictions

© 2003-2005 Transition Networks.

All rights reserved. No part of this work may be reproduced or used in any form or by any means - graphic, electronic, or mechanical - without written permission from Transition Networks.

Printed in the U.S.A.

33278.H
